



Information for First & Second Responders Emergency Response Guide For Vehicle:

Li-ion

2020–22 Honda CR-V Hybrid
5-Door Multipurpose Passenger
Hybrid Electric Vehicle



CR-V
HYBRID

Version 3

This guide has been prepared to assist emergency response professionals in identifying a 2020–22 Honda CR-V Hybrid vehicle and safely respond to incidents involving this vehicle.

Copies of this guide and other emergency response guides are available for reference or downloading at <https://techinfo.honda.com>.

For questions, please contact your local Honda dealer or Honda Automobile Customer Service at **(800) 999-1009**.

Honda wishes to thank emergency response professionals for their concern and efforts in protecting Honda customers and the general public.



Contents

1. Identification / Recognition	Page 04
2. Immobilization / Stabilization / Lifting	Page 10
3. Disable Direct Hazards / Safety Regulations	Page 13
4. Access to the Occupants	Page 16
5. Stored Energy / Liquids / Gases / Solids	Page 22
6. In Case of Fire	Page 24
7. In Case of Submersion	Page 27
8. Towing / Transportation / Storage	Page 28
9. Important Additional Information	Page 37
10. Explanation of Pictograms Used	Page 43

The Honda CR-V Hybrid can be identified by the emblem **CR-V**, mounted on the tailgate and the **HYBRID** emblems mounted on the tailgate and the front fenders.

Under the hood, the CR-V Hybrid can be identified by the orange cables throughout the engine compartment.



A Honda CR-V Hybrid can also be identified by inspecting the VIN at the three locations shown below.

Characters 4 thru 6 of the VIN will show **RT6** indicating that it is a Honda CR-V Hybrid.

7FA **RT6*******000001

VIN plate located on the lower-right corner of the front windshield



Stamped into the floor panel in front of the passenger seat under a plastic panel marked **FRAME NUMBER**



Printed on the VIN label on the driver's doorjamb



Warning Labels

⚠ WARNING

Flammable Refrigerant
CAUTION SYSTEM CONTAINS REFRIGERANT R-1234yf UNDER HIGH PRESSURE.
TO BE SERVICED ONLY BY QUALIFIED PERSONNEL.
Follow Instructions in the service manual.

AIR CONDITIONER SYSTEM
REFRIGERANT : R-1234yf (SAE J639 J2842 J2845)
REC. CHARGE : MAX 0.465kg MIN 0.415kg
OIL TYPE : ND-OIL 11 (POE)

TPG Honda Motor Co., Ltd.

VEHICLE EMISSION CONTROL INFORMATION

CONFORMS TO REGULATIONS: 2020MY HEV

U.S. EPA: T3B30 LDT2	OBD: CA II	FUEL: GASOLINE
CALIFORNIA: SULEV30 LDT2	OBD: CA II	FUEL: GASOLINE
TWC, WR-HO2S, HO2S, SFI, EGR, EGRC		

GROUP: LHNXT02.0WMC EVAP: LHNXR01501SA 2.0L HONDA MOTOR CO., LTD.

5RD-A51 **V·H**

INFORMATION

- THE FACTORY INSTALLED LONG-LIFE COOLANT MUST BE REPLACED ACCORDING TO MAINTENANCE MINDER SUB CODE 5, OR AT 10 YEARS WHICHEVER COMES FIRST. THEREAFTER EVERY 5 YEARS.
- WHEN ADDING OR REPLACING THE COOLANT, ALWAYS USE **Honda RECOMMENDED GENUINE** LONG-LIFE ANTI-FREEZE / COOLANT TYPE 2. THIS COOLANT IS PRE-MIXED WITH 50% DISTILLED WATER. IT DOES NOT REQUIRE ANY ADDITIONAL MIXING.
- NEVER DILUTE THE COOLANT, OR THE LIFE OF THE ENGINE MAY BE SERIOUSLY SHORTENED.
- CHECK OR ADD THE COOLANT AT THE RESERVE TANK, NOT THE RADIATOR.
- FOR FURTHER INFORMATION ON THE COOLING SYSTEM, READ THE OWNER'S MANUAL OR CHECK WITH YOUR Honda DEALER.

NOTICE

If this vehicle is not driven for 3 months or longer, the high-voltage Lithium-ion battery can be permanently damaged due to prolonged low state of charge. To maintain an adequate charge level, drive the vehicle for more than 30 minutes at least once every 3 months.

LITHIUM-ION BATTERY DISPOSAL INFORMATION

A large high-voltage Lithium-ion battery located behind the rear seat in the trunk. The high-voltage Lithium-ion battery requires a special disposal process. Contact American Honda at 1-800-555-3497 for handling and disposal information.

High-voltage Lithium-ion battery

5K1-A1

DANGER WARNING
危険 危険

NEVER OPEN WHEN HOT.
Hot coolant will scald you.
N'OUVREZ PAS QUAND CHAUD.
NICHT BEI HEISSEM MOTOR OFFNEN.
熱い時あけないでください。
高温時、请勿打开

⚠ WARNING

HIGH VOLTAGE
You can be killed or hurt.
Do not disconnect, open, or take apart.

When you remove and attach the PCU
When you remove and attach the PCU, conduct maintenance according to the service manual.

*Under intake air resonator

Warning Labels (continued)

⚠ WARNING

HIGH VOLTAGE

- You can be killed or hurt.
- Do not remove this cover.
- No customer serviced parts inside.

A0

⚠ DANGER	⚠ PELIGRO	⚠ DANGER
<p>IMPACT Strong impact (i.e., dropping the battery, collision damage) may cause electrolyte leaks, internal short circuits and heat increase resulting in fire. Avoid impact to the battery.</p> <p>FLAMMABLE LIQUID and VAPOR Battery damage may cause flammable gas or electrolyte leaks and may result in fire. Do not damage the battery and keep sparks, flame and cigarettes away.</p> <p>CHEMICAL HAZARD - CORROSIVE Organic electrolyte may cause severe burns to skin and eyes. Wear personal protective equipment.</p> <p>POISON Organic electrolyte is poisonous. If ingested, get medical attention immediately.</p> <p>KEEP OUT OF REACH OF CHILDREN</p>	<p>IMPACTO Impacto fuerte (es decir, dejar caer la batería, el daño causado por la colisión) puede causar fuga de electrolitos, cortocircuitos internos y aumento de temperatura pudiendo provocar un incendio. Evite el impacto a la batería.</p> <p>LÍQUIDOS INFLAMMABLES y VAPOR Daño en la batería puede causar fuga de electrolitos o gas inflamable y puede provocar un incendio. No dañe la batería y manténgase lejos de chispas, fuego y cigarrillos.</p> <p>RIESGO QUÍMICO - CORROSIVO El electrolito orgánico puede causar severas quemaduras en la piel y los ojos. Use equipo de protección personal.</p> <p>VENENO El electrolito orgánico es venenoso. En caso de ingestión, busque atención médica inmediatamente.</p> <p>MANTÉNGASE FUERA DEL ALCANCE DE LOS NIÑOS</p>	<p>CHOC Choc important (c'est à dire : faire tomber la batterie, les dommages par collision) peut provoquer des fuites d'électrolyte, courts-circuits internes et l'élévation de la température qui peuvent entraîner un incendie. Éviter tout choc sur la batterie.</p> <p>LIQUIDE et VAPEUR INFLAMMABLES L'endommagement de la batterie peut provoquer des fuites de gaz ou d'électrolyte inflammables et peut entraîner un incendie. Ne pas endommager la batterie. Éloigner de toute étincelle, flamme nue ou cigarette allumée.</p> <p>RISQUE CHIMIQUE - CORROSIF L'électrolyte organique peut causer de graves brûlures à la peau et aux yeux. Porter un équipement de protection individuelle.</p> <p>POISON L'électrolyte organique est toxique. En cas d'ingestion, consulter immédiatement un médecin.</p> <p>GARDER HORS DE LA PORTÉE DES ENFANTS</p>
<p>SHIELD EYES PROTEJA LOS OJOS PROTÉGEZ LES YEUX</p>	<p>NO FIRE NO INCENDIO ÉVITER INCENDIE</p>	<p>CORROSIVE ORGANIC ELECTROLYTE ELECTROLITO ORGÁNICO CORROSIVO ELECTROLYTE ORGANIQUE CORROSIF</p> <p>GET MEDICAL HELP FAST OBTENGA AYUDA MÉDICA RÁPIDA OBTENIR RAPIDEMENT AIDE MÉDICALE</p>
<p> Li-ion</p>		
<p>A0</p>		

LITHIUM-ION BATTERY DISPOSAL INFORMATION

This 259V high voltage battery requires special handling and disposal process. Contact for instructions, in USA : American Honda 1-800-555-3497 in Canada : Honda Canada 1-800-946-6329

MISE AU REBUT DES BATTERIES LITHIUM-ION

La manutention et la mise au rebut de la batterie haute tension de 259V nécessitent un processus spécial. Veuillez contacter pour le processus, dans USA : American Honda au 1-800-555-3497 dans Canada: Honda Canada au 1-800-946-6329

⚠ WARNING

HIGH VOLTAGE

You can be killed or hurt. Do not disconnect, open, or take apart.

⚠ DANGER	⚠ DANGER
<p>HIGH VOLTAGE You will be killed or hurt. Before servicing</p> <ul style="list-style-type: none"> ■ Switch vehicle power mode to off and remove high-voltage battery service plug. ■ Wear insulated gloves and use insulated tools. ■ Check voltage at high-voltage battery box terminals. ■ Follow all service manual instructions. 	<p>HAUTE TENSION Danger de mort ou de blessures. Avant le service</p> <ul style="list-style-type: none"> ■ Mettre le mode d'alimentation du véhicule à OFF, puis retirer le capuchon de la prise de service de la batterie haute tension. ■ Porter des gants isolants et utiliser des outils isolés. ■ Vérifier la tension aux bornes du boîtier de la batterie haute tension. ■ Suivez toutes les instructions du manuel d'atelier.
<p>5RD-A0</p>	

Warning Labels (continued)

⚠ WARNING

⚡ HIGH VOLTAGE
You can be killed or hurt.
Do not disconnect, open, or take apart.

When you remove and attach the PCU
When you remove and attach the PCU, conduct maintenance according to the service manual.

DANGER WARNING
危険 危険

NEVER OPEN WHEN HOT.
Hot coolant will scald you.
N'OUVREZ PAS QUAND CHAUD.
NICHT BEI HEISSEM MOTOR ÖFFNEN.
熱い時あけないでください。
高温時、请勿打开
49kPa

INFORMATION

- ▶ INVERTER COOLANT MAINTAIN ACCORDING TO THE SERVICE MANUAL.
- ▶ MAINTENIR LA QUANTITÉ DE RÉFRIGÉRANTE DE L'ONDULEUR SELON LE MANUEL DE SERVICE.
- ▶ MANTENGA LA CANTIDAD DE REFRIGERANTE DEL INVERSOR CONFORME AL MANUAL DE SERVICIO.
- ▶ インバータ冷却水はサービスマニュアルに従って整備してください。
- ▶ 按照維修手冊，保持逆變器冷卻劑量。

5KO

⚠ WARNING

⚡ HIGH VOLTAGE
You can be killed or hurt.
Do not disconnect, open, or take apart.

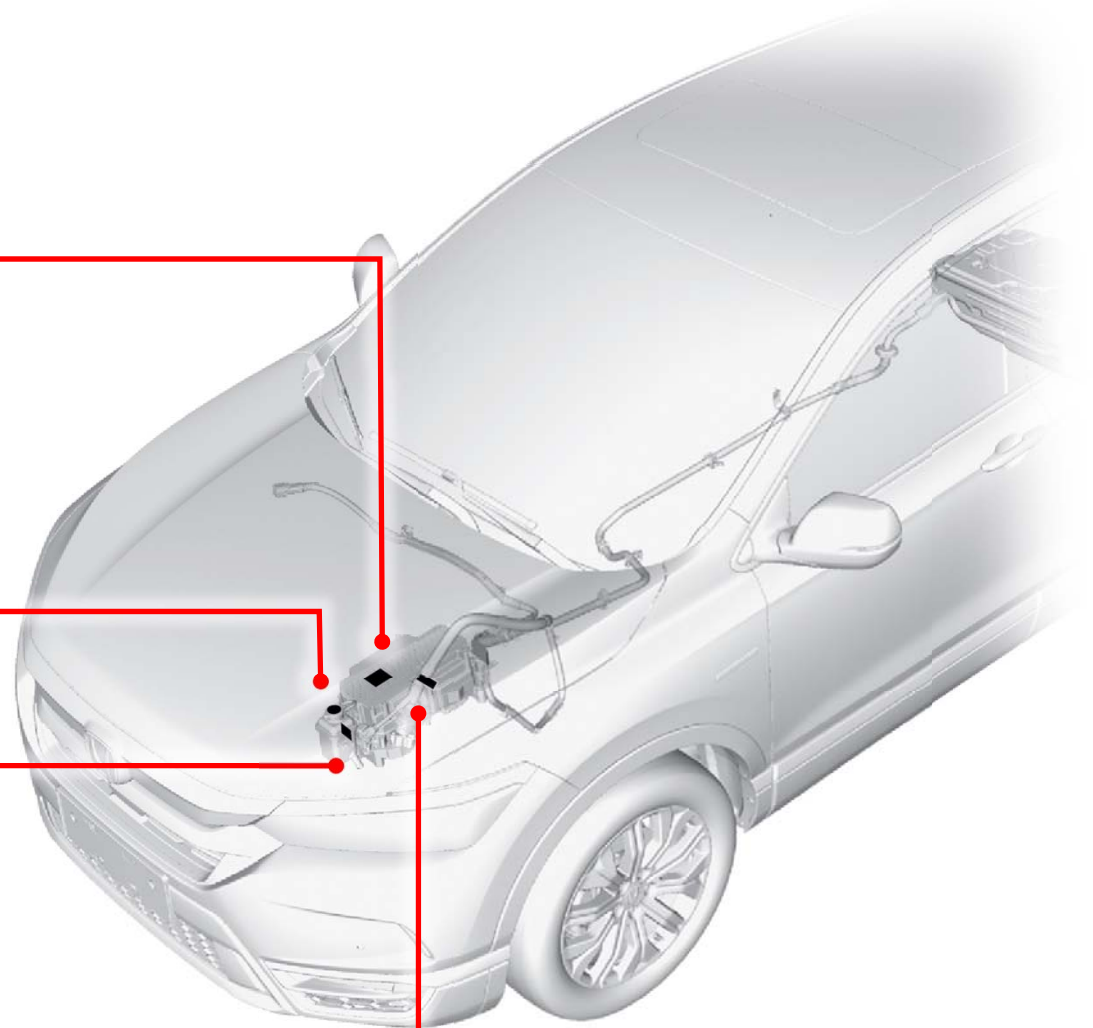

High-Voltage Battery - Location

The high-voltage battery is located behind the rear seats in the rear cargo compartment.

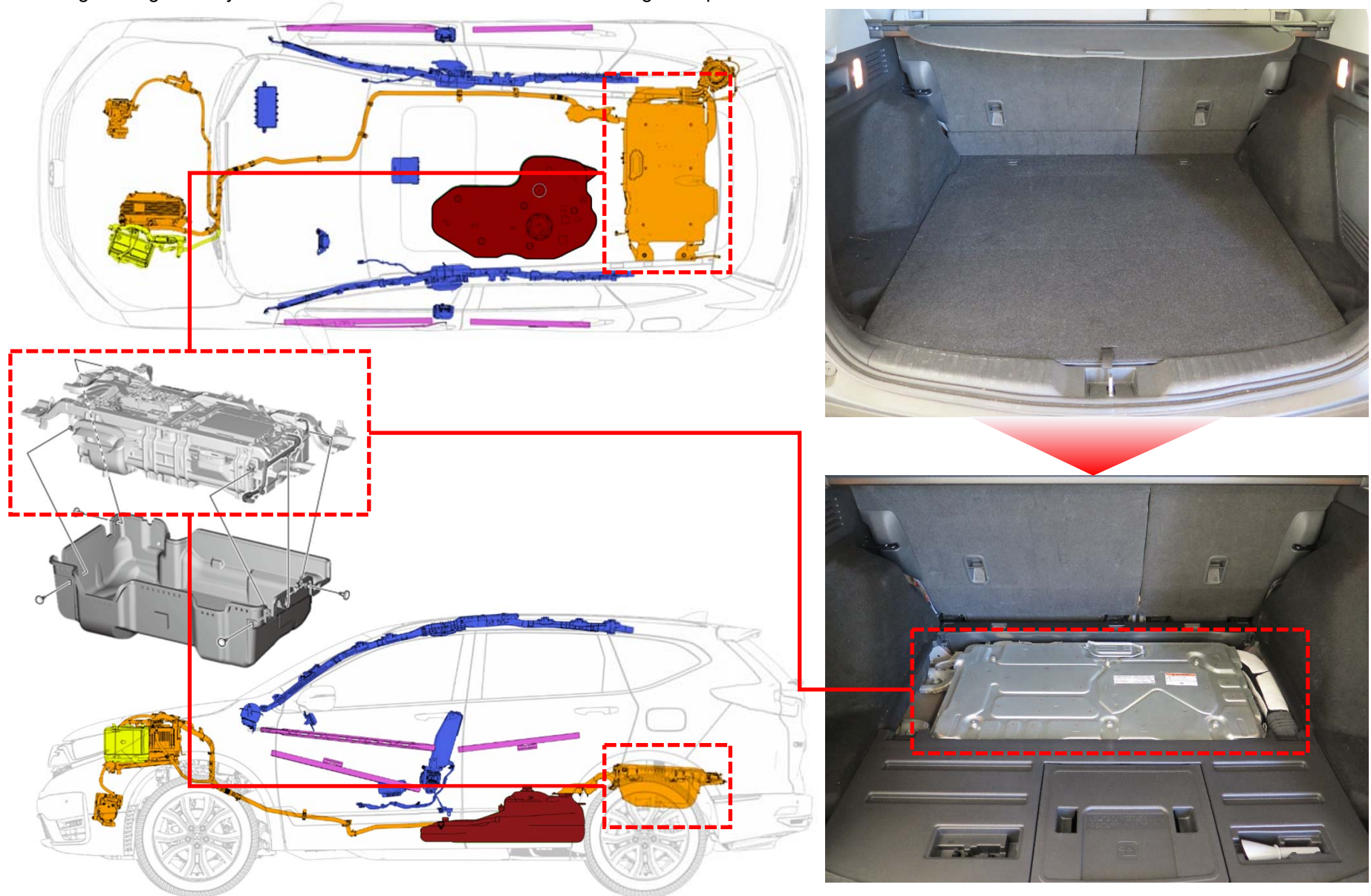

How to Determine if Vehicle is in ON / OFF Mode.

Check the illumination of the **POWER** button of the vehicle status.



Vehicle is OFF

The power to all electrical components is turned off.

- Press the **POWER** button to change to the Accessory mode.



Vehicle is in Accessory

You can operate the audio system and other accessories in this position.

- Press the **POWER** button once to change to the ON mode.
- Press the **POWER** button twice to turn off the vehicle



Vehicle is ON

The Engine is **OFF** but all electrical components can be used.

- While pressing the brake pedal, press the **POWER** button once to start the engine.
- Press the **POWER** button once to turn off the vehicle.



Start the Engine

The Engine is **ON** with the **EV Ready** indicator on. All electrical components can be used.

- While pressing the brake pedal, press the **POWER** button once.
- Press the **POWER** button once to turn off the vehicle.



Parking the Vehicle

NOTE:

- The following features will only operate if the vehicle's 12-volt battery power is available.
- If the 12-volt power IS NOT available, use available wheel chocks.

1. Pull up the Electric Parking Brake switch to apply the parking brake.
2. Push the POWER button to turn the vehicle to the ON mode. Refer to page 10 for instructions.
3. If necessary, press the **P** to shift the transmission to Park.
4. Push the **POWER** button to turn off the vehicle.



Applying the Electric Parking Brake

The electric parking brake can be applied any time the vehicle has battery power no matter what state the power mode is in.

Pull up the Electric Parking Brake switch gently and securely.

The parking brake and Brake System indicator come on.

Releasing the Electric Parking Brake

The power mode must be turned to ON to release the electric parking brake.

1. Press the brake pedal.
2. Press the Electric Parking Brake switch.

The parking brake and Brake System indicator go off.



Lifting the Vehicle

Use the indicated lifting points to raise the vehicle.

Front Lifting Points (Only If Necessary)

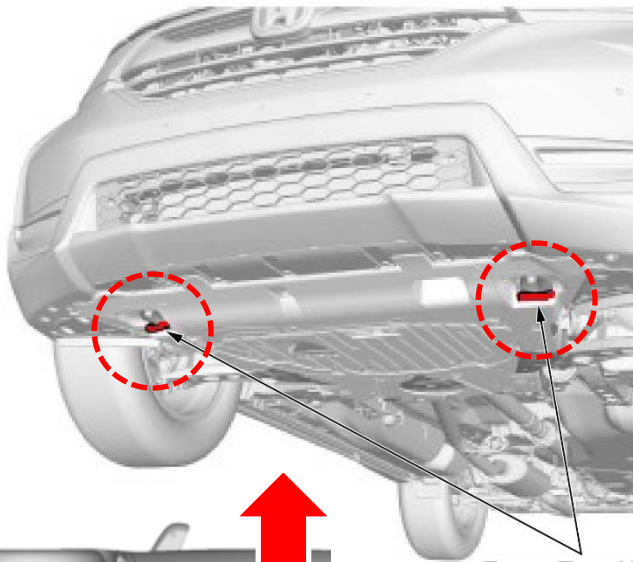

Front Tow Hooks

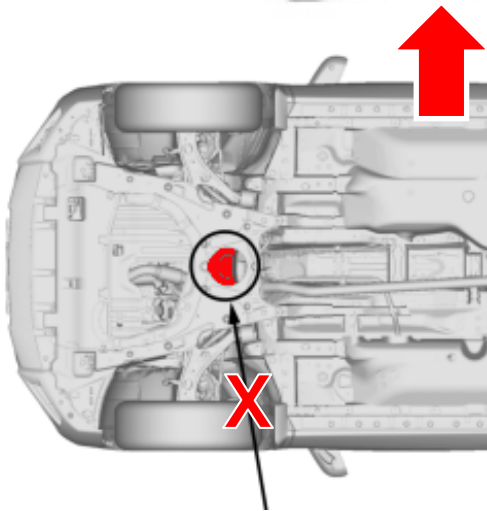

Front Lift Point

If the front lifting point is not accessible, use the front tow hooks.

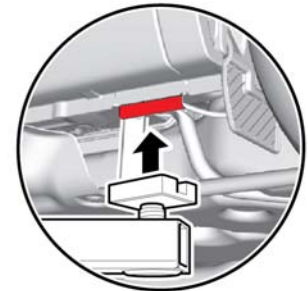
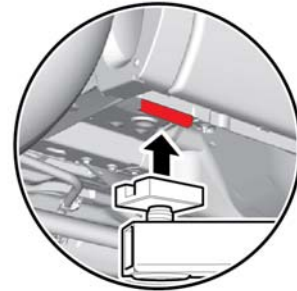
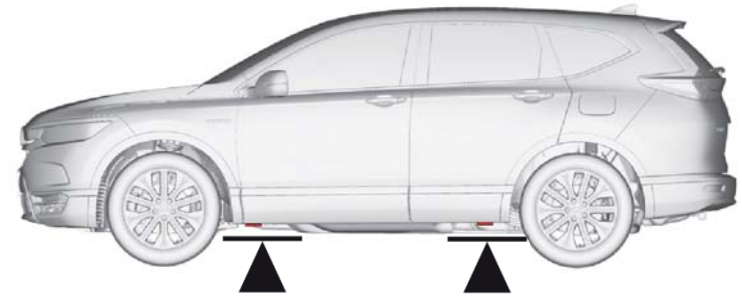

Recommended Lifting Points

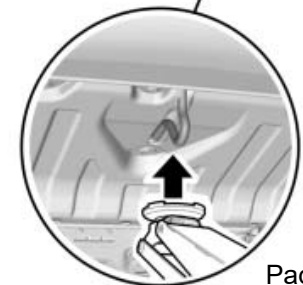
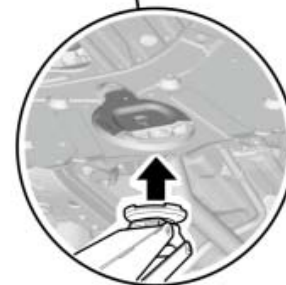
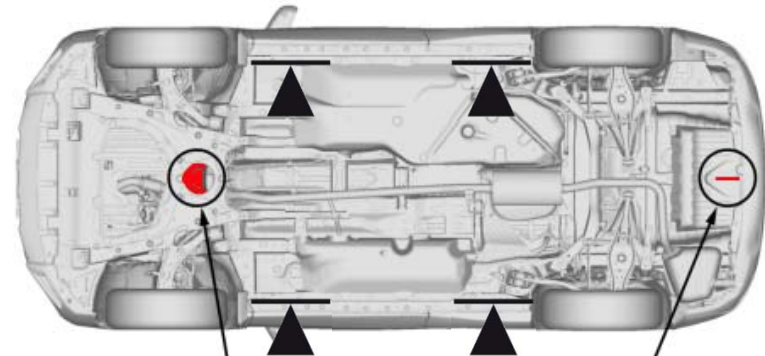

Preventing Current Flow Through High-Voltage Cables

Before attempting to rescue occupants or move a damaged Honda CR-V Hybrid, you should reduce the potential for current to flow from the electric motor or the high-voltage battery through the high-voltage cables.

There are *two recommended methods* for preventing current flow. These are discussed on the following pages.

PREFERRED METHOD for High-Voltage Shutdown
Push and hold the POWER button for 3 seconds.



20 FEET



This simple action turns off the vehicle and immediately shuts down the high-voltage system controllers, thereby preventing current flow into the cables. It also cuts power to the airbags and the front seat belt tensioners, though these pyrotechnic devices have up to a **3-minute** deactivation time.

To prevent accidental restarting, you must remove the keyless remote from the vehicle and move it at least **20 feet** away.

If you cannot locate the keyless remote, disconnect the negative terminal from the 12V battery to prevent electrical fires and accidental restarting of the vehicle.

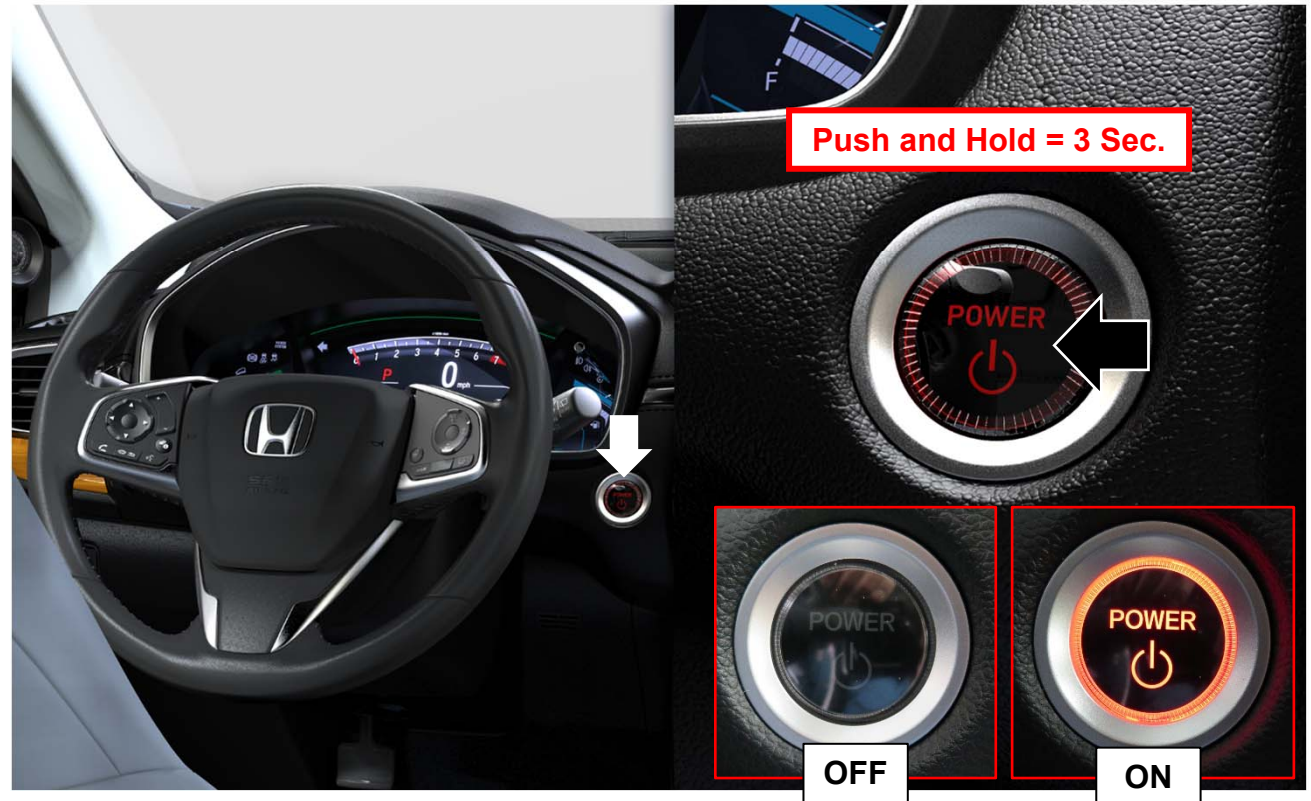

HIGH-VOLTAGE SHUTDOWN PROCEDURE (PREFERRED)

ALTERNATIVE BEST METHOD for High-Voltage Shutdown

Locate and cut the negative 12-volt battery cable and the power control unit (PCU) cable in the engine compartment.

Together, cutting the negative 12-volt battery cable and the PCU cable immediately turns off and shuts down the high-voltage system controllers and the engine, thereby preventing current flow into the high-voltage cables.

1. Pull the hood release handle under the driver's side lower corner of the dashboard. The hood will pop up slightly.
3. Remove the support rod from the clamp using the grip. Mount the support rod in the hood.

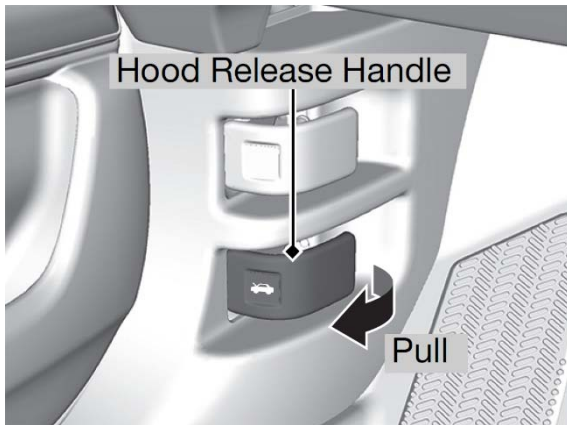

2. Push the hood latch lever (located under the front edge of the hood to the center) to the side, and raise the hood. Once you have raised the hood slightly, you can release the lever.

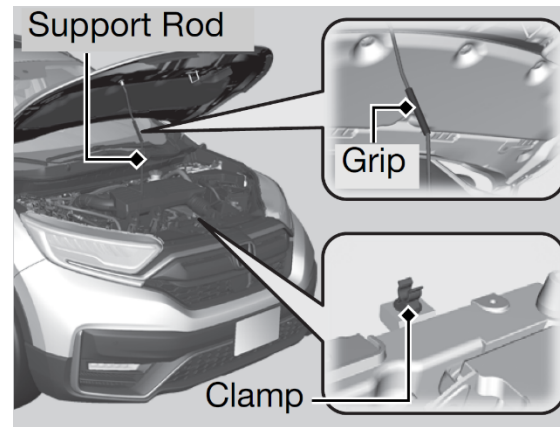
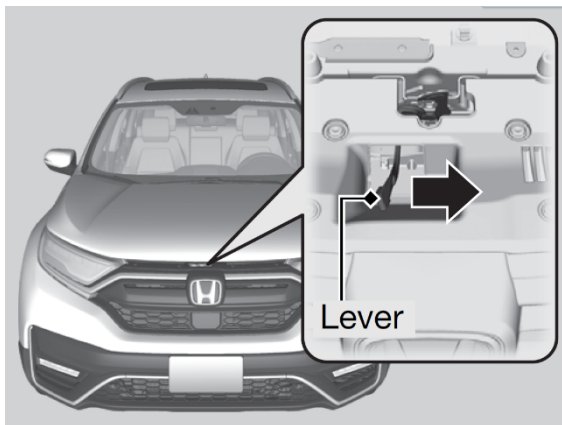

ALTERNATIVE BEST METHOD for High-Voltage Shutdown (continued)

4. Locate the two cut point labels as shown, and cut them.

If touching high-voltage cables and other high-voltage components is unavoidable, personal protective equipment (insulating gloves, goggles, and boots) should always be worn.

This also cuts power to the airbags and the front seat belt tensioners, though these pyrotechnic devices have up to a **3-minute** deactivation time.

NOTE:

When cutting the cables, do not allow the cutting tool to contact any surrounding metal parts; electrical arcing could occur, which can ignite any flammable vapors.

If you cannot do either method to stop the engine and prevent current flow into the high-voltage cables, use extreme care and do not touch damaged cables as they may be electrically charged.

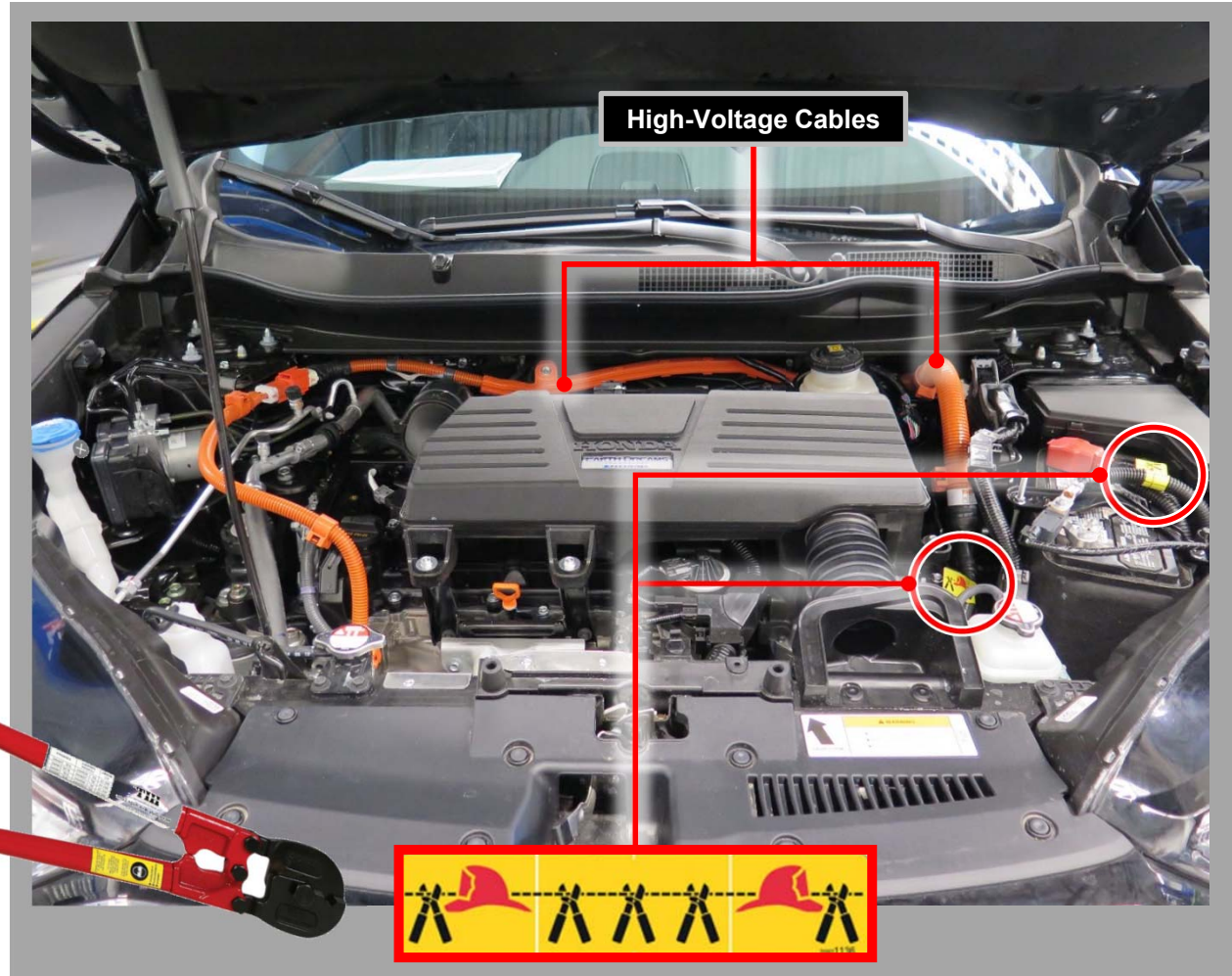

HIGH-VOLTAGE SHUTDOWN PROCEDURE (ALTERNATIVE)

High-Strength and Ultra-High-Strength Steel

The body of the Honda CR-V Hybrid is made of high-strength steel and ultra-high-strength steel indicated in the colored areas.

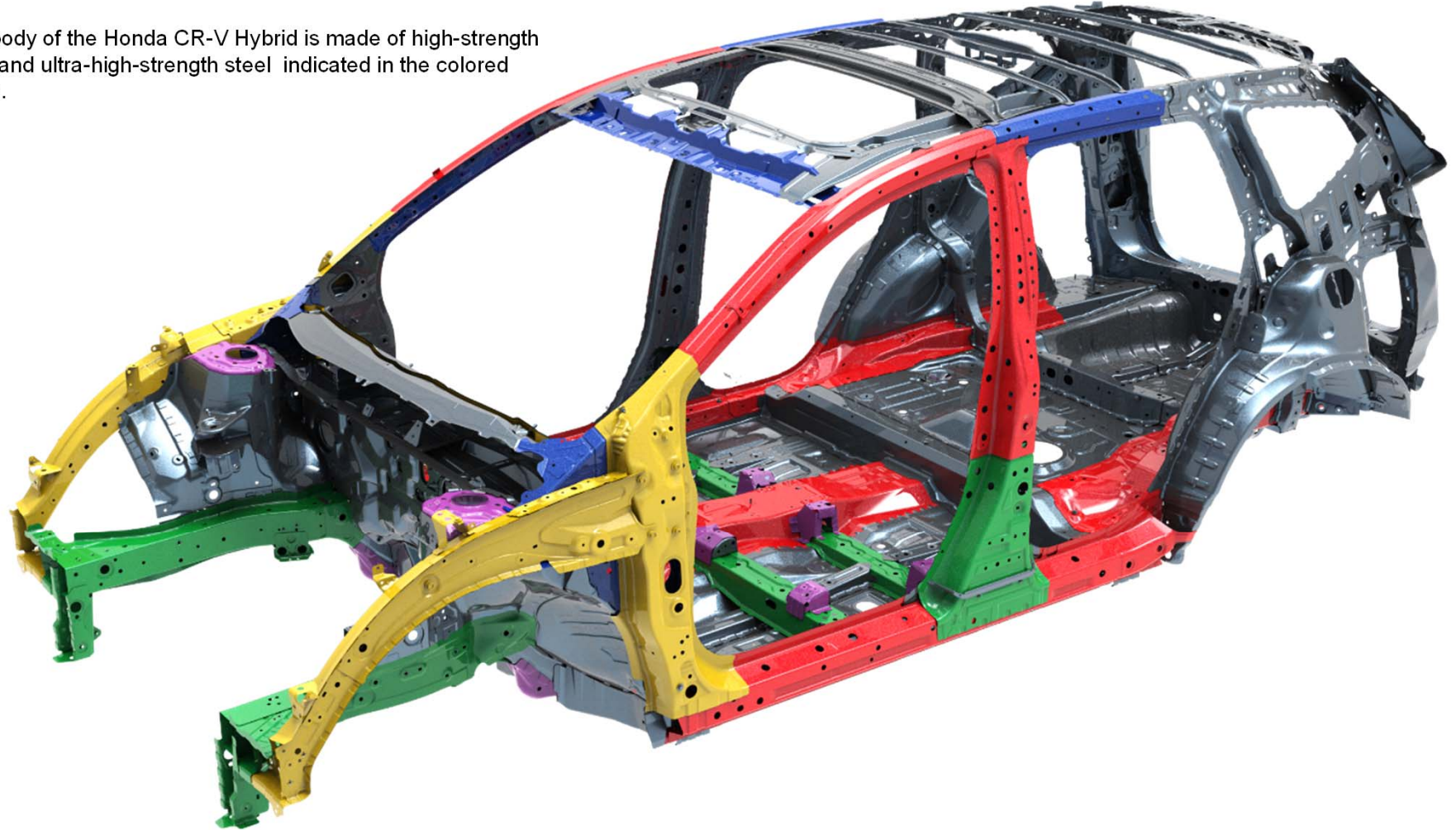

Ultra High-Strength Steel (UHSS)

High-Strength Steel (HSS)

1500
Mpa

980
Mpa

780
Mpa

590
Mpa

440
Mpa

270
Mpa

High-Strength and Ultra-High-Strength Steel

The body of the Honda CR-V Hybrid is made of high-strength steel and ultra-high-strength steel indicated in the colored areas.

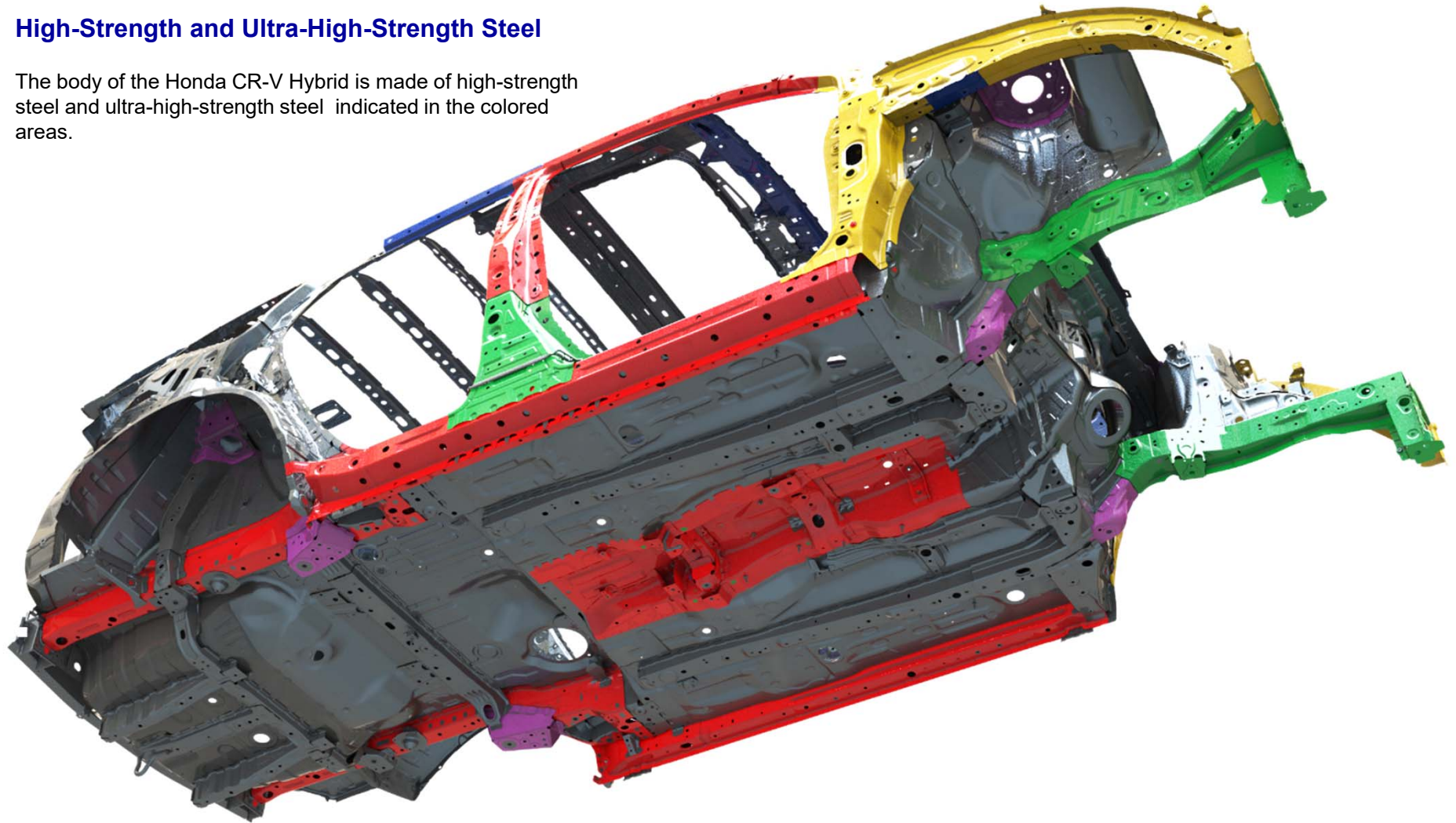

Ultra High-Strength Steel (UHSS)

High-Strength Steel (HSS)

1500
Mpa

980
Mpa

780
Mpa

590
Mpa

440
Mpa

270
Mpa

Exterior Body Parts

Except for the aluminum hood, the exterior body parts are made of high-strength steel and ultra-high-strength steel indicated in the colored areas.

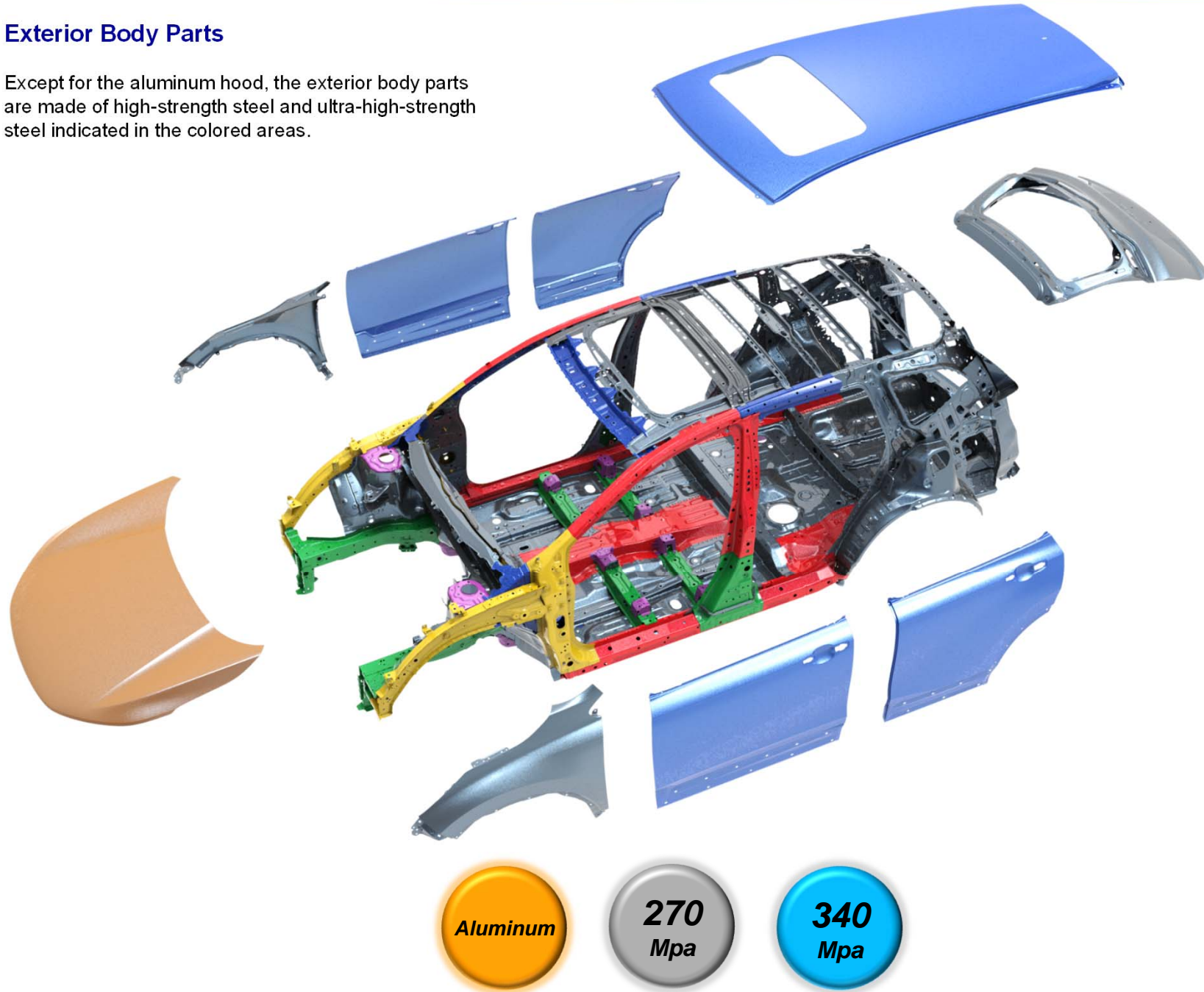

Extricating Occupants

If you need to cut the hood to open it, be sure to stay within the cut zone as shown.

When cutting the vehicle body, personal protective equipment (insulating gloves, goggles, and boots) should always be worn.



If you need to cut the vehicle body or use Jaws-of-Life equipment to remove occupants, be sure to stay within the cut zone as shown.

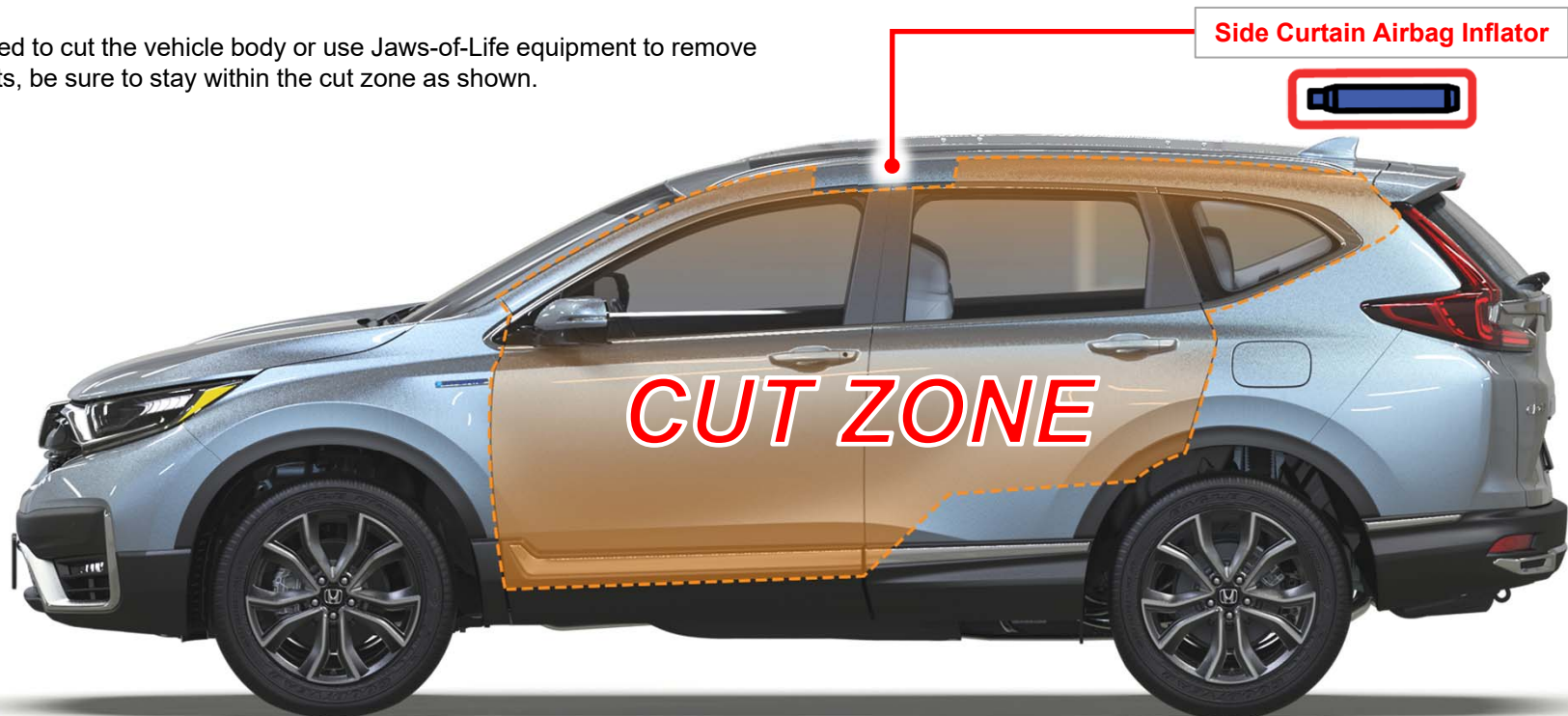

Moving the Seats, Head Restraints & Steering Wheel

With Power Seats



To raise the head restraint: Pull upward.

To lower the head restraint: Push down while pressing the release button.

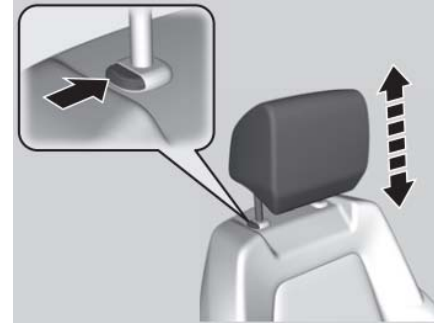

With Manual Seats

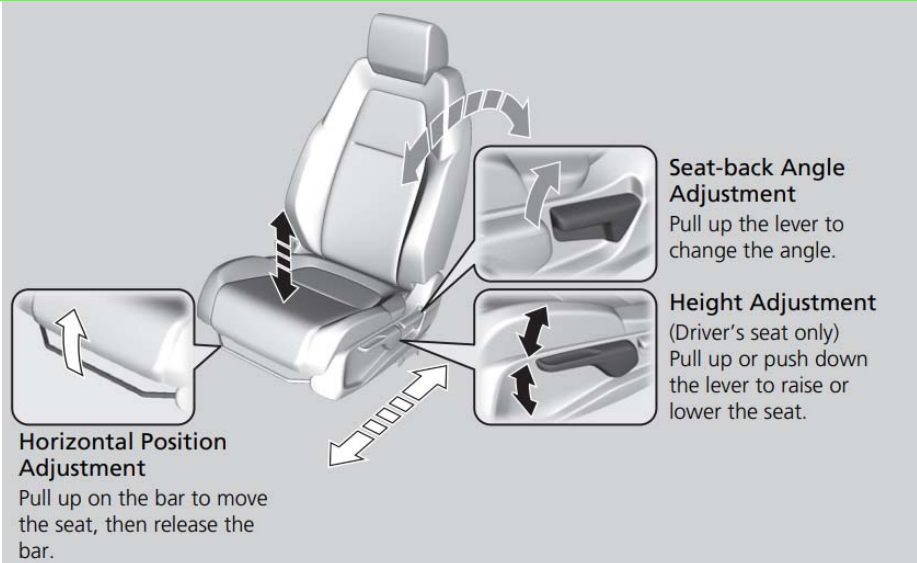

To adjust the steering wheel position:

1. Pull the steering wheel adjustment lever up. The steering wheel adjustment lever is under the steering column.
2. Move the steering wheel up or down, and in or out.
3. Push the steering wheel adjustment lever down to lock the steering wheel in position.

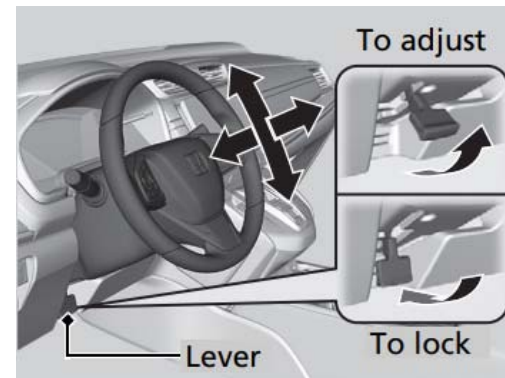

Opening the Tailgate

1. Open the rear tailgate. There are three available options.

- Press the tailgate open switch on the tailgate (all models).
- Press the tailgate open/close switch located on the dashboard, left of the steering wheel (models with power tailgate).
- Press and hold the tailgate open/close button on the keyless remote (models with power tailgate).



PRESS & HOLD

In the event of a 12-volt power failure or mechanical tailgate failure

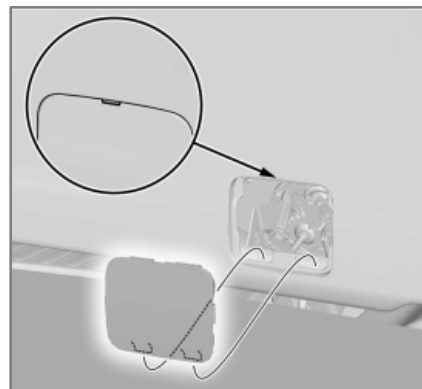

From inside the vehicle, remove the lid on the tailgate panel using a small, flat-tip screwdriver.











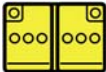







Push the tab in the direction shown



Push the tab in the direction shown



Type	Capacity	Content	Dangers
12-Volt Battery 	12 V—44.65 Ah/20 HR (12 V—38 Ah/5 HR)	<ul style="list-style-type: none"> • Sulfuric acid 34% • Lead 34% • Lead peroxide 31% • Lead sulfate 1% 	 
Lithium-Ion, High-Voltage Battery 	266.4 V 72 cells (3.7 V) (18 cells × 4 modules)	<ul style="list-style-type: none"> • Aluminum 20-30% • Lithium metal oxide 15-25% • Graphite 5-15% • Copper 15-25% • Organic electrolyte 15-25% (Maximum volume: 50 cc) • Graphite 5-15% 	 
Engine Oil	4.8 US qt (4.5 L)	<ul style="list-style-type: none"> • Distillates, petroleum, hydrotreated heavy paraffinic 	  
Gasoline Tank 	14 US gal (53 L)	<ul style="list-style-type: none"> • Gasoline 88-100% • Ethanol Less than 10% • Toluene Less than 10% • 1,2,4-Trimethylbenzene Less than 5% • Benzene Less than 5% • N-Hexane Less than 3% 	 
Engine Coolant	1.46 US gal (5.52 L)	<ul style="list-style-type: none"> • Water 45-55% • Ethylene glycol 43-49 % • Hydrated inorganic acid, organic acid salts Less than 5% • Diethylene glycol Less than 3% 	
High-Voltage Battery Coolant	0.423 US gal (1.60 L)		

Type	Capacity	Content	Dangers
Transmission Fluid	3.7 US qt (3.5 L)	<ul style="list-style-type: none"> • Lubricating base stocks 80-90% • N-Phenyl-1-naphthylamine less than 1% 	
Rear Differential Fluid	1.6 US qt (1.5 L)	<ul style="list-style-type: none"> • Base Oil(s) 70-80% • Additives less than 30% 	Not provided on SDS
Brake Fluid	N/A	<ul style="list-style-type: none"> • Mixture of glycol ether, glycol derivative, glycol ether borate ester (except diethylene glycol) 89-99% • Diethylene glycol Less than 10% 	Not provided on SDS
Air Conditioning Refrigerant 	14.6 – 16.4 oz (415 – 465 g)	<ul style="list-style-type: none"> • Tetrafluoroprop-1-ene (R-1234yf) 100% 	
Windshield Washer Fluid	2.6 US qt (2.5 L)	<p>Concentrate</p> <ul style="list-style-type: none"> • Methyl Alcohol (methanol) more than 99% <p>Tablet</p> <ul style="list-style-type: none"> • Sodium carbonate (2:1) 40 to 55% • Citric acid 20 to 40% • Ethoxylated fatty alcohols 0.1 to 3% • Alkoxyated alcohols 0.1 to 2% 	

High-Voltage Battery Access

1. Open the rear tailgate. There are three available options:

- Press the tailgate open switch on the tailgate (all models)
- Press the tailgate open/close switch located on the dashboard, left of the steering wheel (models with power tailgate).
- Press and hold the tailgate open/close button on the keyless remote (models with power tailgate).



2. Remove the cargo area floor lid.

NOTE: The lid is secured with two (JIS) screws at the front cargo hooks. In the event of an emergency, remove the lid with extrication equipment as necessary.

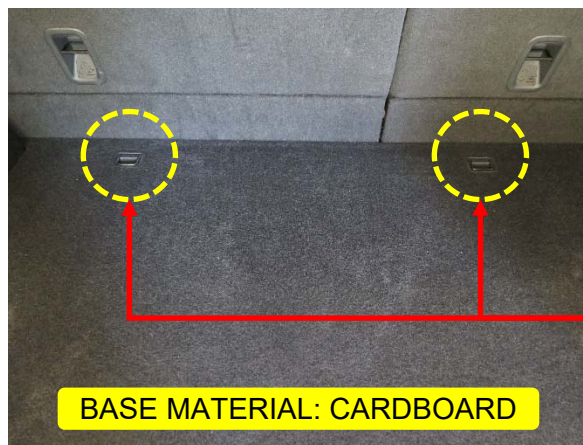

Fire Extinguishing Methods

In case of vehicle high-voltage battery fire, the fire should be extinguished using the following procedure where possible.

If touching high-voltage cables and other high-voltage components is unavoidable, personal protective equipment (insulating gloves, goggles, and boots) should always be worn.

1. Open the tailgate and remove the cargo area floor lid to assess the extent of crash damage and fire.
2. Extinguish the fire using a large volume of water such as from a fire hydrant, well water, or pond water. If water is not available, ABC powder fire extinguisher may be used as an alternative. Apply directly to the high-voltage battery unit where fire is present.
 - Remove the air cooling ducts to further direct water into the battery unit.
 - If an opening to the battery cover exists as a result of the crash damage or fire, water may also be directed through this opening.
3. Continue extinguishing until a complete suppression of fire and smoke is observed from the battery.
4. Once signs of active fire have subsided completely (e.g. visible smoking), a thermal camera should be used to evaluate and monitor the temperature of the battery unit.

NOTE:

The battery temperature should continue to be monitored. If the battery temperature begins to increase, possibility for reignition exists and additional water or fire extinguisher should be used to mitigate reignition.

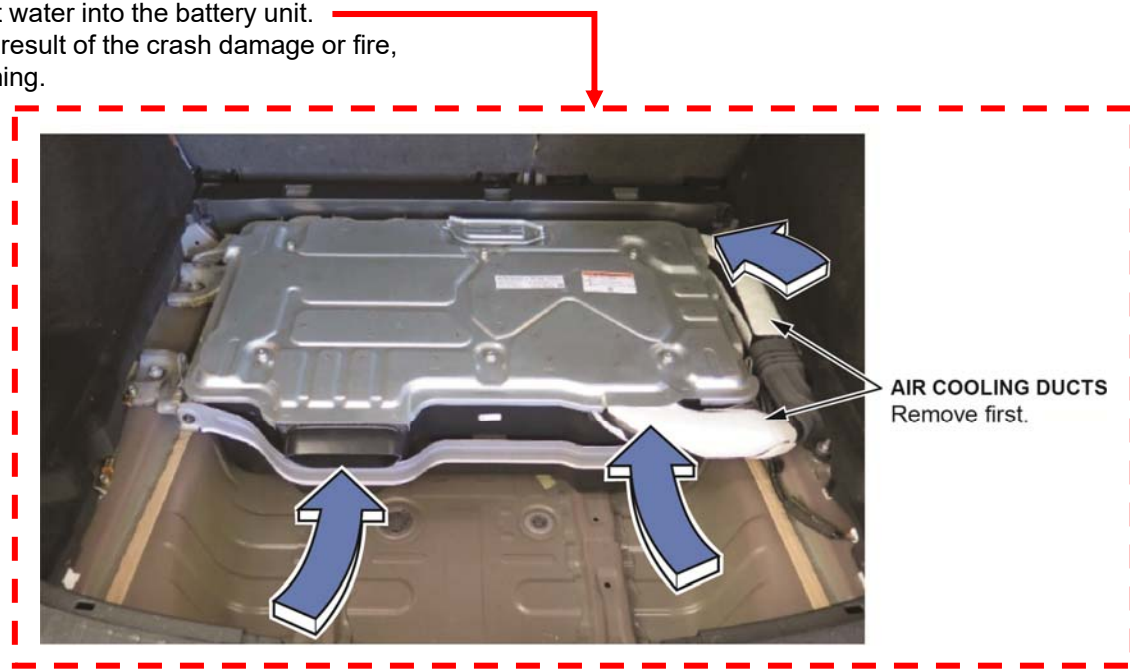

WARNING:

- Do NOT attempt to open the battery cover at this time.
- Never use seawater or any water containing salt.
- Always assume the high voltage battery contains stranded energy and a possibility for reignition exists.

See Section 8 (Towing/Transportation/Storage) for additional procedures including discharging the high voltage battery.



High-Voltage Battery Access

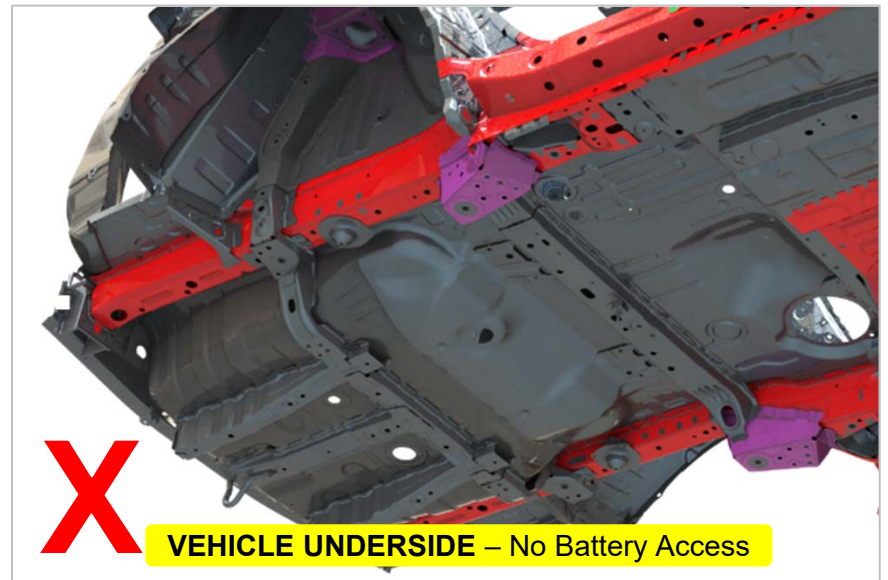
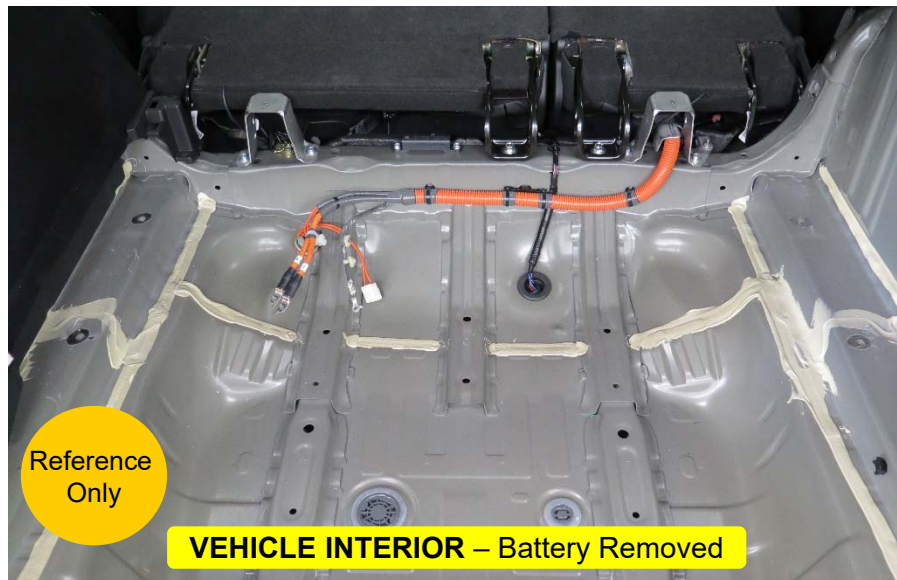
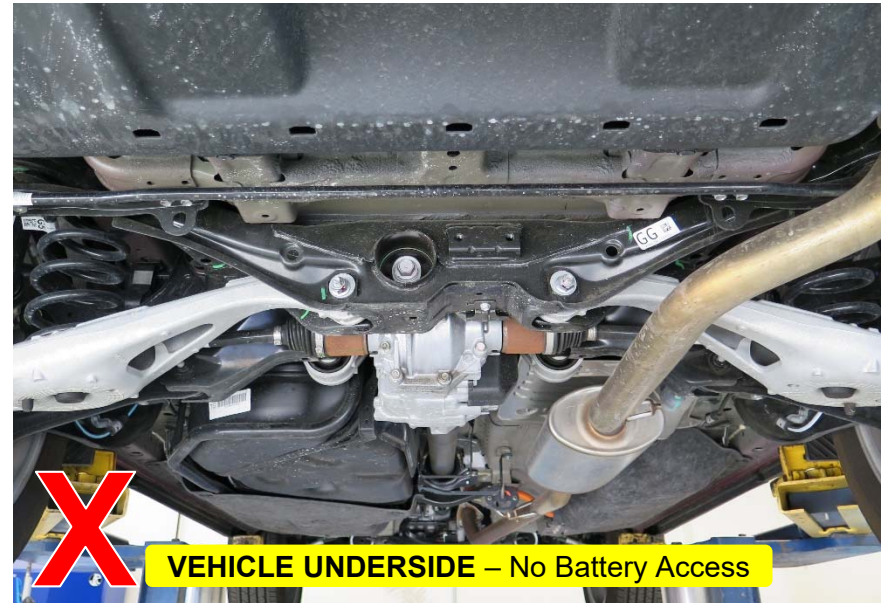
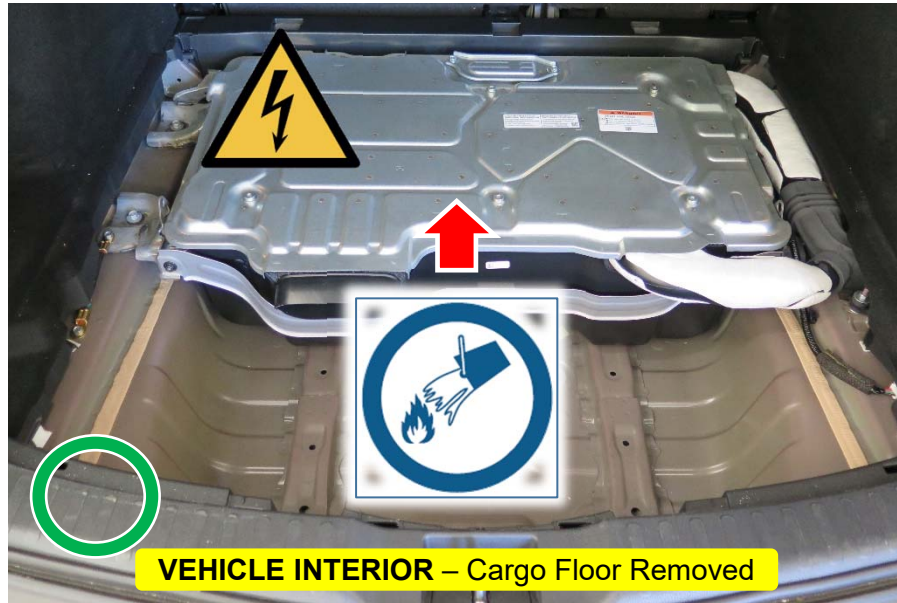

Submerged Vehicle

If a Honda CR-V Hybrid is submerged or partly submerged in water, first pull the vehicle out of the water, then shut down the high-voltage system. *See Section 3 (Disable Direct Hazards / Safety Regulations for the high-voltage shutdown procedures).*

If touching high-voltage cables and other high-voltage components is unavoidable, personal protective equipment (insulating gloves, goggles, and boots) should always be worn.



Aside from severe damage to the vehicle, there is no risk of an electric shock from touching the vehicle's body or framework—in or out of the water. If the high-voltage battery was submerged, you may hear noises from the battery as the cells are being discharged from shorting.

See Section 8 (Towing/Transportation/Storage) for additional procedures including discharging the high voltage battery.

Shifting the Vehicle into Park or Neutral

1. Pull up the Electric Parking Brake switch to apply the parking brake.
2. Press the P to shift the transmission to Park.
3. Push the **POWER** button to turn off the vehicle.



Electric Parking Brake Switch

Applying the Electric Parking Brake

The electric parking brake can be applied any time the vehicle has battery power no matter what state the power mode is in.

Pull up the Electric Parking Brake switch gently and securely.

The parking brake and Brake System indicator come on.



Electric Parking Brake Switch

Releasing the Electric Parking Brake

The power mode must be turned to ON to release the electric parking brake.

1. Press the brake pedal.
2. Press the Electric Parking Brake switch.

The parking brake and Brake System indicator go off.

Keeping the Transmission in Neutral

With the power system turned to ON, do the following steps:

1. Press and hold the brake pedal.
2. Press and release N to shift the transmission to Neutral. The message, Neutral Hold will appear on the gauge.
3. Press N again, and hold it for **2 seconds**. The vehicle will enter neutral hold.

NOTE:

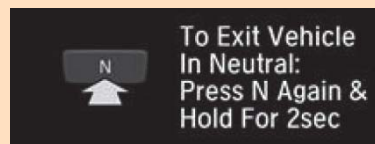
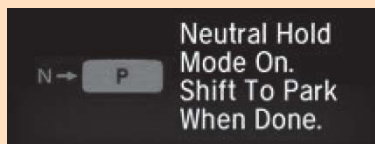

- If the POWER button is pressed after neutral hold has been activated, the power mode will switch to ACCESSORY and a message will be displayed on the gauge.
- For **15 minutes** the transmission remains in neutral and the power mode will remain in ACCESSORY. After that, the transmission automatically shifts to park.
- Manually shifting to park cancels ACCESSORY mode. The P indicator comes on, and the power mode changes to OFF. You must always shift the transmission to park when neutral hold is no longer necessary.



Emergency Towing

The only method for emergency towing is to use a flat-bed tow truck. **DO NOT** use cable type or front wheel type lift equipment.

NOTE: If there is a 12-volt power failure, the vehicle cannot be shifted into neutral. Use available wheel dollies.

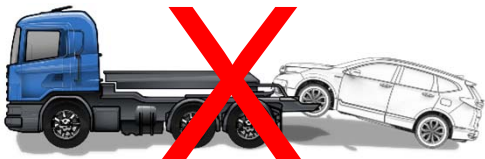
Flat-Bed	Cable-Type	Front Wheel Type
		
<p>1. Secure the vehicle on the flat-bed tow truck. 2. Apply the parking brake.</p>	<p>Never tow this vehicle with cable-type equipment.</p>	<p>Never tow this vehicle with front wheel type equipment</p>

Be aware that when rolling a Honda CR-V Hybrid with the front (drive) wheels on the ground, the electric motor can produce electricity and remains a potential source of electric shock even when the high-voltage system is turned off.

Carry a fire extinguisher during transportation and for enhanced safety, have the flat-bed tow truck with the damaged vehicle followed by another support vehicle for monitoring. After transportation, discharge the battery if it is necessary. See Battery Discharging in this section.

⚠ WARNING

If orange high-voltage cables or high-voltage covers have been damaged, exposing wiring, terminals, or other components, the exposed parts should never be touched. Doing so could result in serious injury or death due to severe burns or electric shock.

If it is not clear whether the exposed wires and terminals are high-voltage components or not, do not touch them.

If touching high-voltage cables and other high-voltage components is unavoidable, personal insulating protective equipment (insulating gloves, protective goggles, and insulating boots) should always be worn.

Acoustic Vehicle Alerting System

The Honda CR-V Hybrid is equipped with an acoustic vehicle alerting system and alerts pedestrians with an audible sound that it is approaching when the speed is about **14 mph** or less. When pushing the Honda CR-V Hybrid with the ignition turned to ON, you will hear this sound as the vehicle is being moved.



Lifting the Vehicle

Use the indicated lifting points to raise the vehicle.

Front Lifting Points (Only If Necessary)

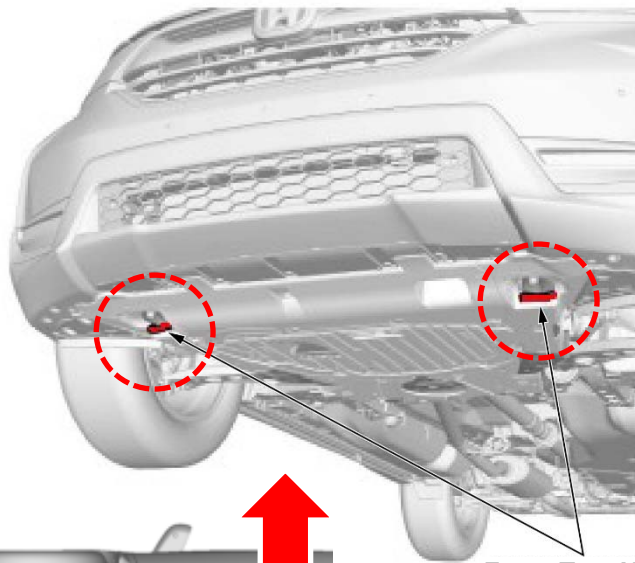

Front Tow Hooks

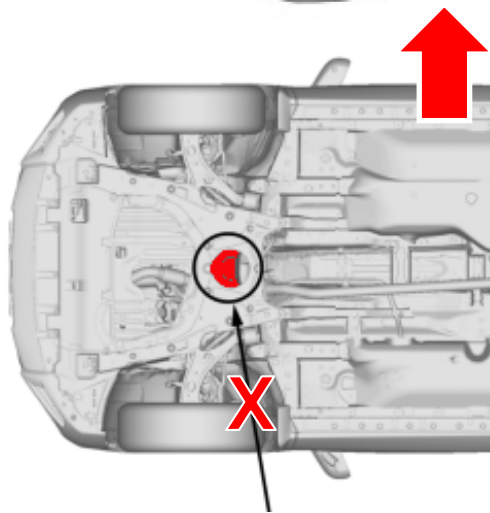

Front Lift Point

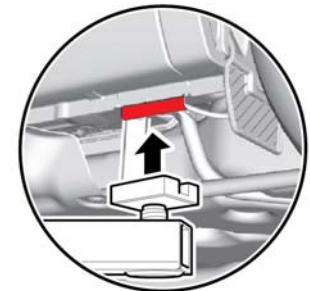
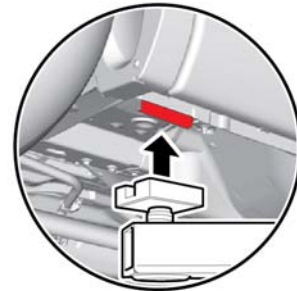
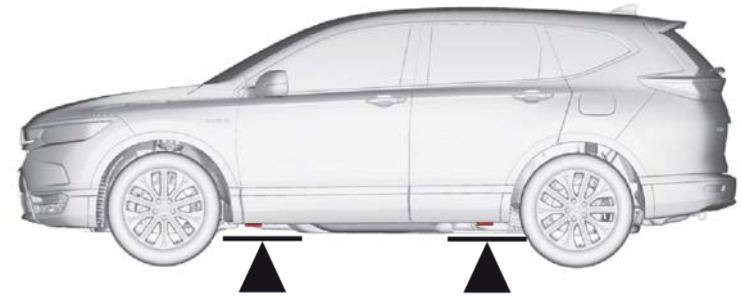

Recommended Lifting Points

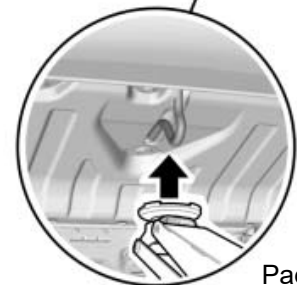
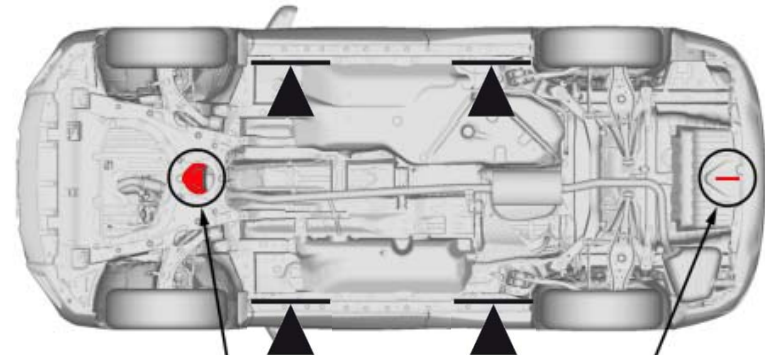

If the front lifting point is not accessible, use the front tow hooks.

Securing the Vehicle

The recommended tie-down locations for securing the vehicle are indicated below.

- Four tie-down slots - Two behind the front wheels and two in front of the rear wheels
- Two front tow hooks – One each in the front of the left-front tire and right-front tire
- Single tow hook in the rear

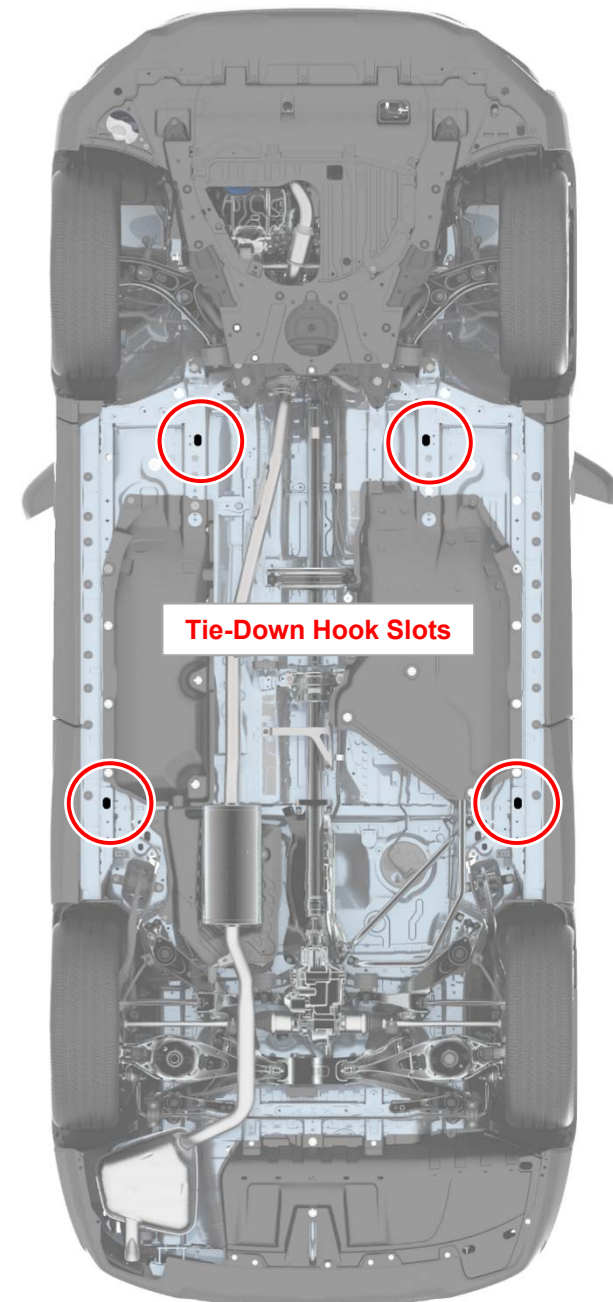

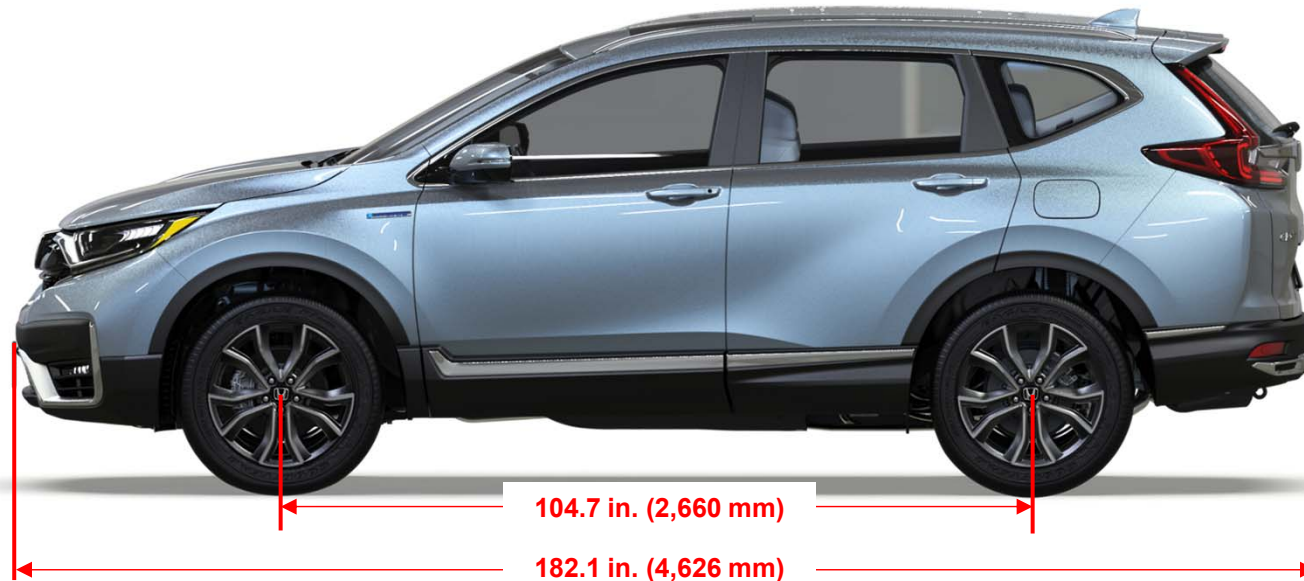

Curb Weight Rating
3,649 lb (1,655 kg) ~ 3,763 lb (1,707 kg)

Storing the Vehicle

Storage and isolation recommendations.

1. Open Perimeter Isolation:

- Store the vehicle in an outdoor area separated from all combustibles and structures by a minimum distance of **50 feet (15.2 m)** from all sides.

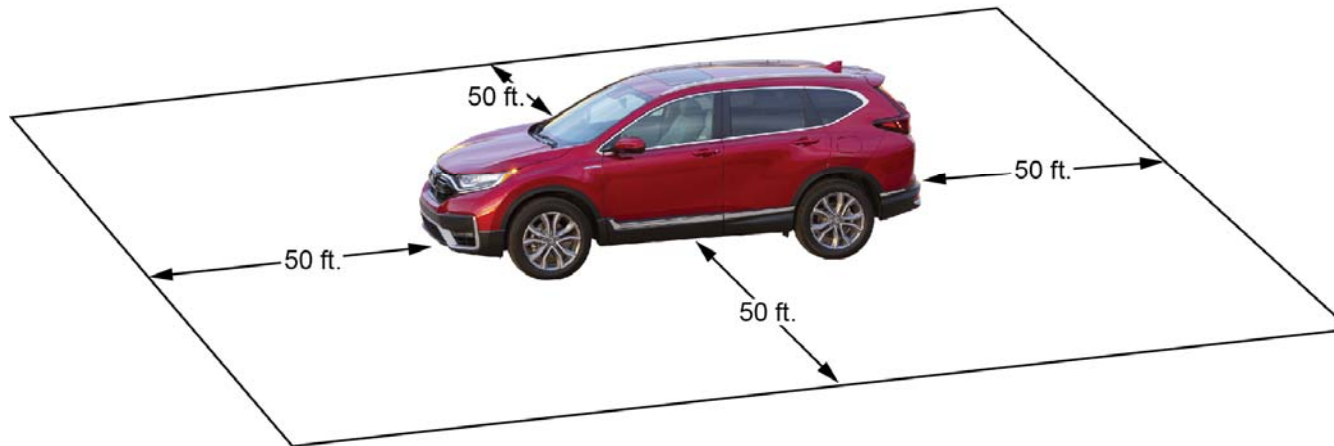

2. Barrier Isolation:

- Store the vehicle in an outdoor area separated from all combustibles and structures with a barrier constructed of earth, steel, concrete or solid masonry designed to contain a fire or prevent the fire from extending to adjacent vehicles.
- Barriers should be of sufficient height to direct any flame or heat away from adjacent vehicles.
- If the barrier is provided only on three of the four sides of the vehicle, the open side must maintain the separation distance referenced in Open Perimeter Isolation.
- It is not recommended to fully enclose the vehicle in a structure due to the risk of post-incident fire extending to the structure and the possibility of trapped explosive or harmful gases. Therefore, a roof is not recommended for barrier isolation.

Battery Discharging

If the high-voltage battery is severely damaged or burned, or the vehicle has been submerged and water has entered and accumulated on the floor of passenger compartment, the battery must be discharged. Failure to discharge stored or stranded energy remaining in the battery may result in a fire or re-ignition due to a damaged or short circuit.

1. Set up a pool approximately **18 feet long x 8.2 feet wide x 3.3 feet high** outdoor in a well-ventilated area.
2. Use a forklift or similar equipment to place the vehicle in the center of the pool.
3. Open the windows or doors as there is as risk of hydrogen gas filling the interior.
4. Open the rear tailgate and remove the cargo area floor lid. **See Section 6 (In Case of Fire – High-Voltage Battery Access).**
5. Remove the service plug lid using a 10 mm wrench.

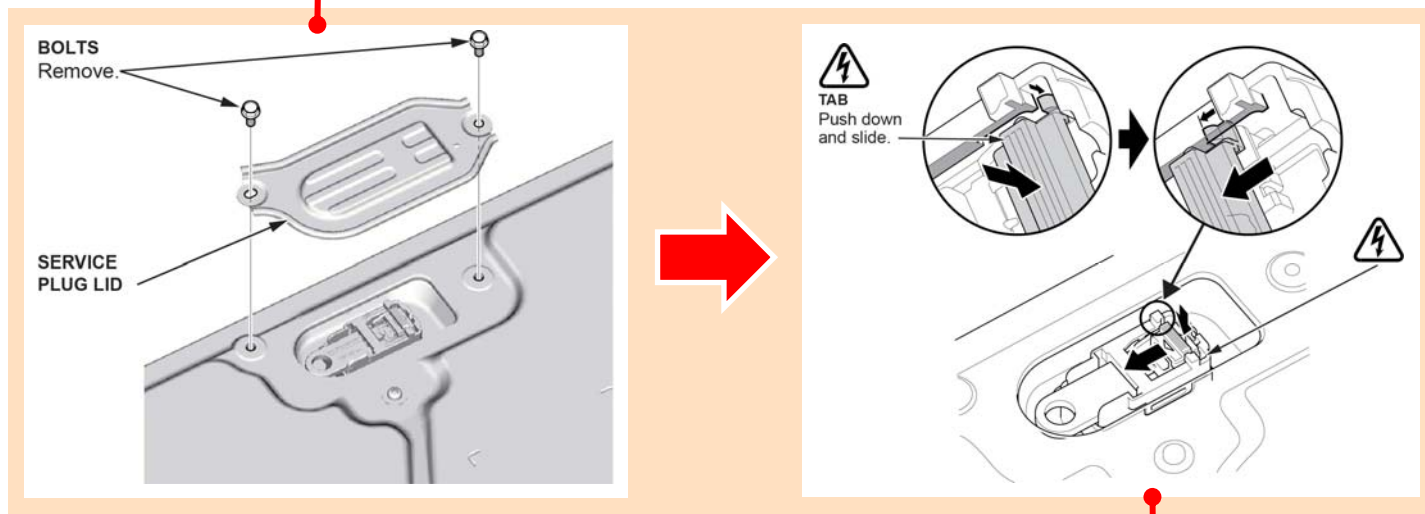

6. Push down and slide back the tab on the service plug until you hear a click.

Continued on the next page.



Battery Discharging (continued)

7. Raise the lever and remove the service plug.

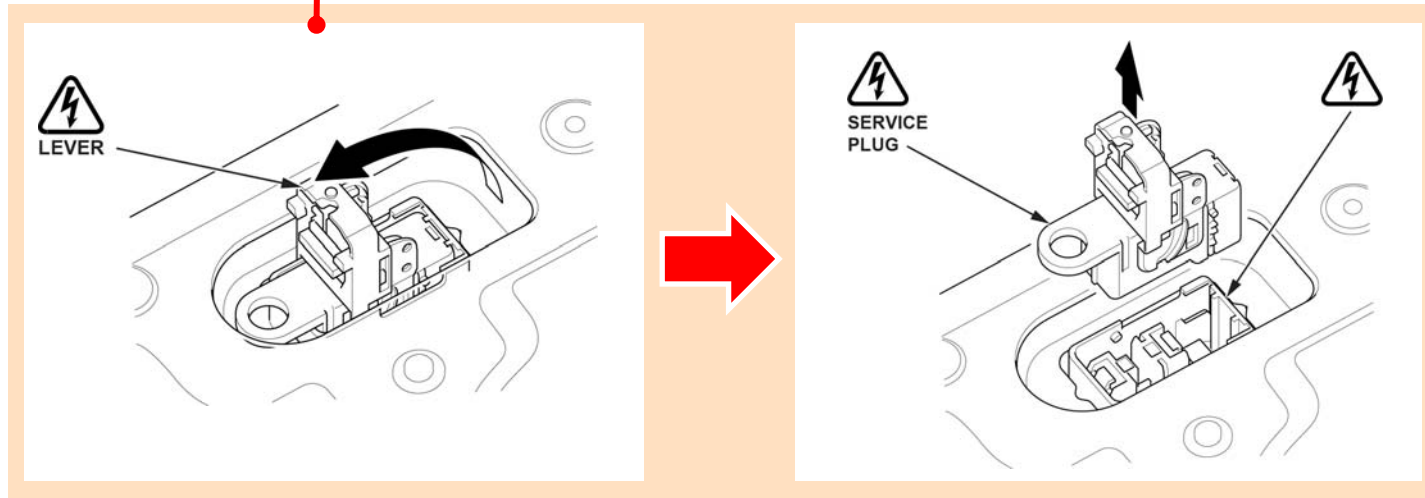

8. Using a TORX T27 driver, remove the six TORX bolts securing the high-voltage battery lid. Remove the high-voltage battery lid.

TORX BOLTS (6)
Remove.

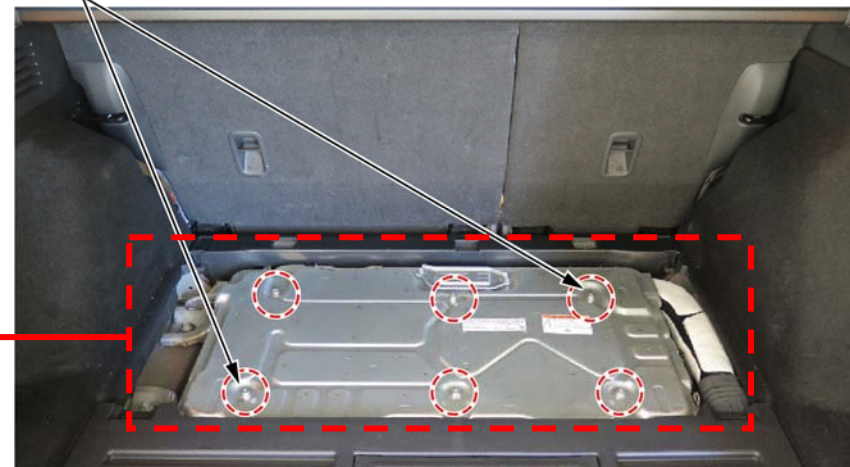

Continued on the next page.



Battery Discharging (continued)

9. Fill the easy set pool with water from a fire hydrant, well water, or pond water until the high voltage battery is completely submerged. If there is a risk of water leakage from the easy set pool, place a thick plastic sheet under the pool.

Never use seawater or any water containing salt.



10. Continue filling the easy set pool to a minimum depth of **2.7 feet (820 mm)** until the high voltage battery is completely submerged, or roughly **4 inches (100 mm)** above the height of the tire.

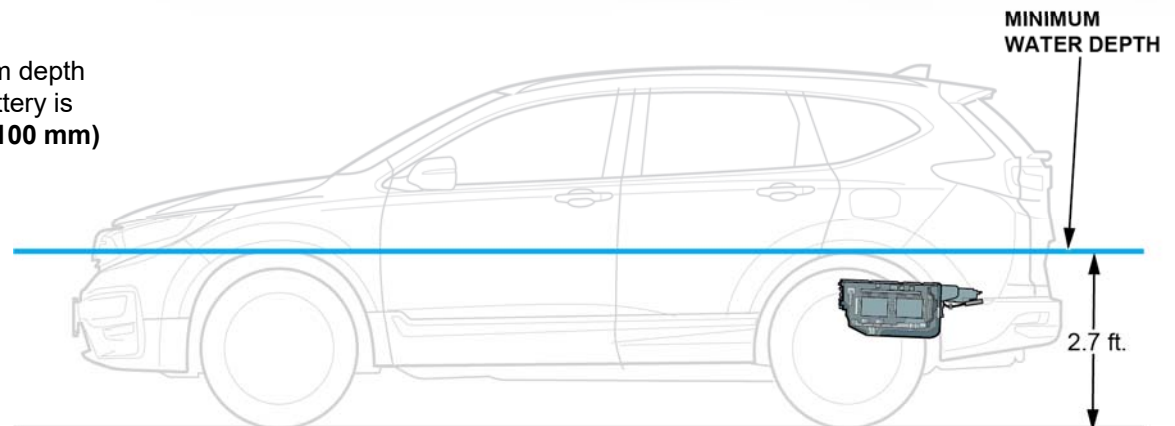

11. Maintain this water level for at least **3.5 days**. If the water level drops below the minimum specified level, add fresh water.

Since the water used for discharging the battery is converted to an aqueous solution containing metals such as Phosphorus (P) and Lithium (Li), dispose of it properly as an industrial waste according to local regulations.



Lithium-Ion Battery Fumes or Fire

A damaged high-voltage lithium-ion battery can emit toxic fumes, and the organic solvent used as electrolyte is flammable and corrosive. Responders should wear appropriate personal protective equipment. Even after a lithium-ion battery fire appears to have been extinguished, a renewed or delayed fire can occur. The battery manufacturer cautions responders that extinguishing a lithium-ion battery fire will take a large and sustained volume of water.

In order to minimize the possibility of collateral fire damage, responders should always ensure that a Honda CR-V Hybrid with a damaged battery is kept outdoors and far away from other flammable objects.



Lithium-Ion Battery Fluid

Avoid contact with the high-voltage battery fluid. The high-voltage battery contains a flammable electrolyte that could leak as a result of a severe crash. Avoid any skin or eye contact with the electrolyte as it is corrosive. If you accidentally touch it, flush your eyes or skin with a large quantity of water for at least **5 minutes** and seek medical attention immediately.

Electric Shock

Unprotected contact with any electrically charged high-voltage component can cause serious injury or death. Receiving an electric shock from a Honda CR-V Hybrid, however, is highly unlikely because of the following:

- Contact with the battery module or other high-voltage components can only occur if they are damaged and the contents are exposed, or if they are accessed without following proper precautions.
- Contact with the electric motor can only occur after one or more components are removed.
- The high-voltage cables can be easily identified by their distinctive orange color, and contact with them can be avoided.

If severe damage causes high-voltage components to become exposed, responders should take appropriate precautions and wear appropriate insulated personal protective equipment.



Disposal

The lithium-ion battery, the high-voltage battery fluid, and the water used to discharge the battery must be properly disposed of as industrial waste according to local regulations.

Seat Belts and Airbags

The Honda CR-V Hybrid is equipped with lap/shoulder belts in all seating positions. The front seat belts are equipped with pyrotechnically activated tensioners that help tighten the seat belt in a sufficient crash.

In addition, the Honda CR-V Hybrid is equipped with the following airbags:

- **Front Airbags** – Driver/Front Passenger
- **Side Airbags** – Driver/Front Passenger
- **Side Curtain Airbags** – Driver's Side/Passenger Side

It takes up to **3 minutes** for the airbags and tensioners to power off after the 12-volt system has been turned off by following the emergency shutdown procedures described in this guide.

In a collision severe enough to deploy one or more of the airbags, the Honda CR-V Hybrid electrical system is designed to automatically open the high-voltage electrical contactors. This disconnects the high-voltage battery from the other high-voltage components and stops the flow of electricity in the high-voltage cables.

However, responders should always assume that the high-voltage system is powered on, and take the appropriate action described in this guide to power off the system.



Vehicle Collision

In the event of a crash, the supplemental restraint system (SRS) unit makes a judgment based on input from the impact sensors. If the input values meet various threshold requirements, the SRS unit sends a signal to the high-voltage battery electronic control unit (ECU). The high-voltage battery ECU then turns off the high-voltage battery contactors, stopping the flow of electrical current from the high-voltage battery.

When responding to an incident involving a Honda CR-V Hybrid, we recommend that emergency personnel follow their organization's standard operating procedures for assessing and dealing with vehicle emergencies.

Honda recommends that responders follow the procedures in this guide to avoid potentially lethal shock from high voltage.



Dealer Inspection and Repair

A damaged Honda CR-V Hybrid should be taken to an authorized Honda dealer for a thorough inspection and repairs. For questions or to locate an authorized Honda dealer, please contact your local Honda dealer or Honda Automobile Customer Service at **(800) 999-1009**.



High-Voltage Battery Recycling

The high-voltage lithium-ion battery requires special handling and disposal. If disposal is necessary, please contact your local Honda dealer or American Honda's Hybrid Battery Consolidation Center at **(800) 555-3497**.



BLUE SKIES FOR
OUR CHILDREN

This guide has been prepared to assist emergency response professionals in identifying a 2020-22 Honda CR-V Hybrid vehicle and safely respond to incidents involving this vehicle.

Copies of this guide and other emergency response guides are available for reference or downloading at <https://techinfo.honda.com>.

For questions, please contact your local Honda dealer or Honda Automobile Customer Service at **(800) 999-1009**.

Honda wishes to thank emergency response professionals for their concern and efforts in protecting Honda customers and the general public.



Components

High-Voltage Components



12-Volt Battery



SRS Components

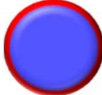

Gas Strut



Fuel Tank









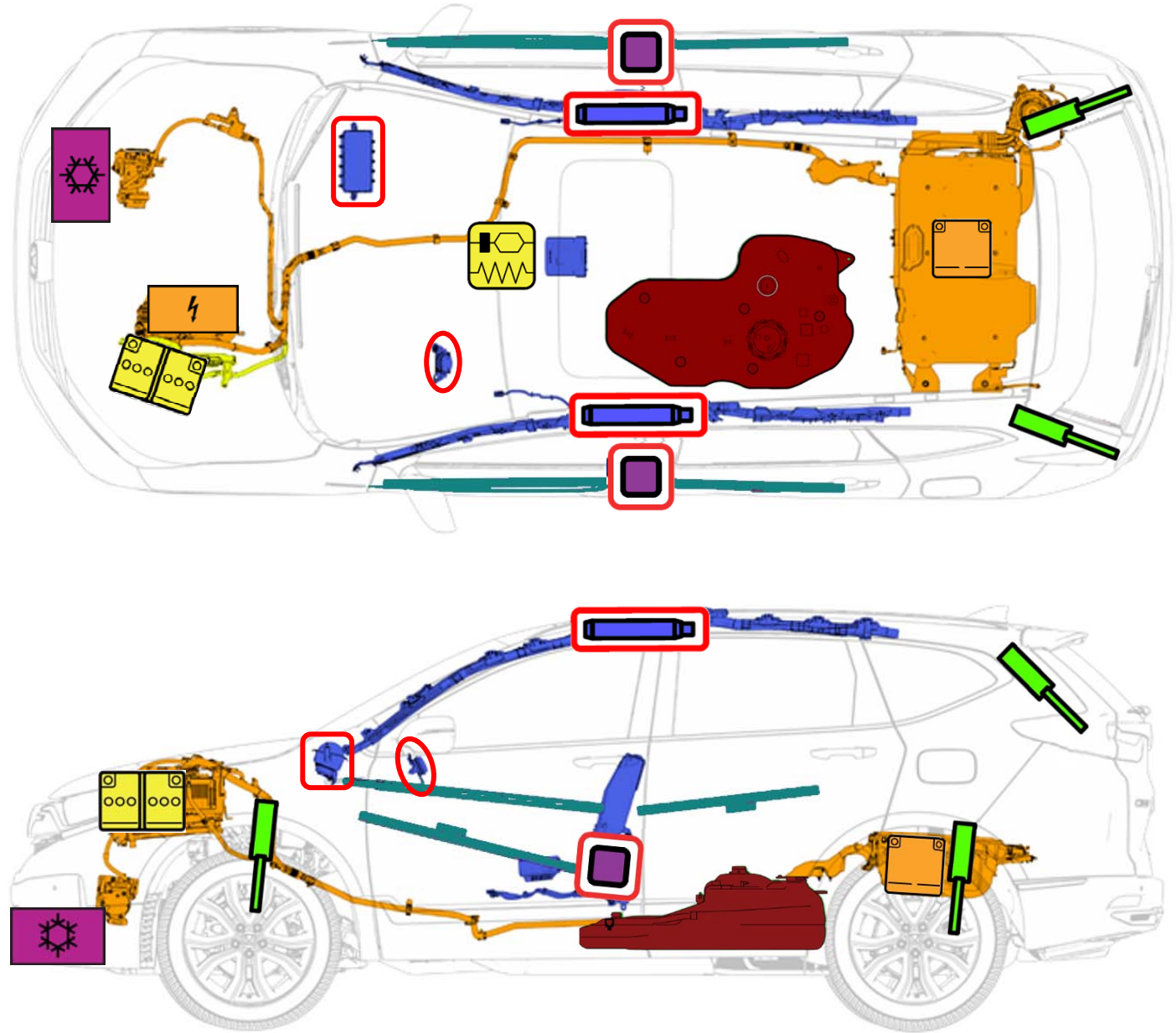

























Reinforcement



Seat Belt Pretensioners



Pictogram	Name	Pictogram	Name
	Hood release/opener control		SRS control unit
	Tailgate/cargo area opener control		High-voltage battery pack
	Power switch		High-voltage component
	Keyless operation key distance		High-voltage power cable
	Fuse box disabling high-voltage		Fuel tank (gasoline)
	Cable to cut to disconnect high-voltage		Air-conditioning component
	High-voltage service plug		General warning
	Steering wheel height adjustment control		Electricity or dangerous voltage
	Seat height adjustment control		Use a thermal infrared camera
	Forward or backward seat adjustment control		Use water to extinguish the fire
	Lifting point		Use ABC powder to extinguish the fire
	Airbag		Flammable
	Airbag inflator		Gases under pressure
	Seat belt pretensioner		Corrosive
	Gas strut		Hazardous to human health
	12-volt battery		Environmental hazard

HONDA