

## 2022 Civic Model Series: New Body Repair Information

### APPLIES TO

2022 Civic Series	2025 Civic Hybrid
-------------------	-------------------

This publication contains a summary of new body and vehicle technologies that may affect collision and other body repairs. Always refer to the service information and body repair manual (BRM) for complete repair information. A subscription may be purchased at [techinfo.honda.com](https://techinfo.honda.com).

### OVERVIEW OF BODY FEATURES



- Next-Generation Advanced Compatibility Engineering™ (ACE™) body structure.
- Body construction using high-strength steel (HSS) and advanced high-strength steel.
- Aluminum hood panel, and front and rear bumper beams for weight reduction and improved fuel economy.
- **1500 MPa** inner and outer door stiffener rings.

### BODY CONSTRUCTION AND HIGH STRENGTH STEEL CONTENT

- Steel parts are color coded based on their tensile strength in megapascals (MPa).
- High-strength steel (HSS) is defined as any steel with a tensile strength of **340 MPa** or higher.
- Ultra-high-strength steel (UHSS) is defined as any steel with a tensile strength of **980 MPa** or higher.
- Steel repair and welding procedures vary depending on the tensile strength of the parts involved.

NOTE: The illustrations below are for general reference only. Some body parts are constructed from multiple layers of different tensile strength steels. Always refer to the body construction section of the BRM for specific steel tensile strength information.

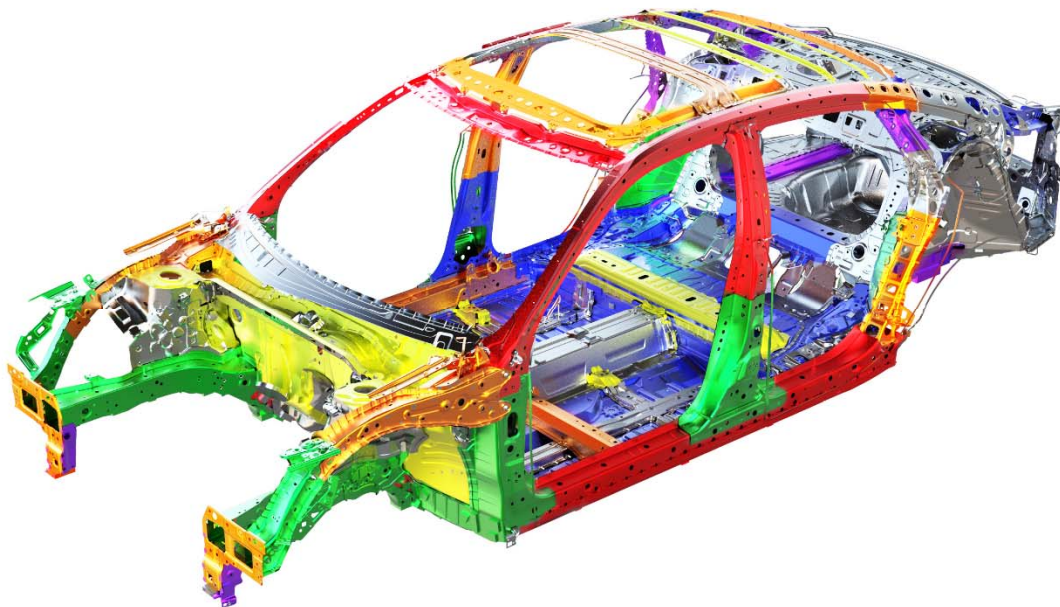

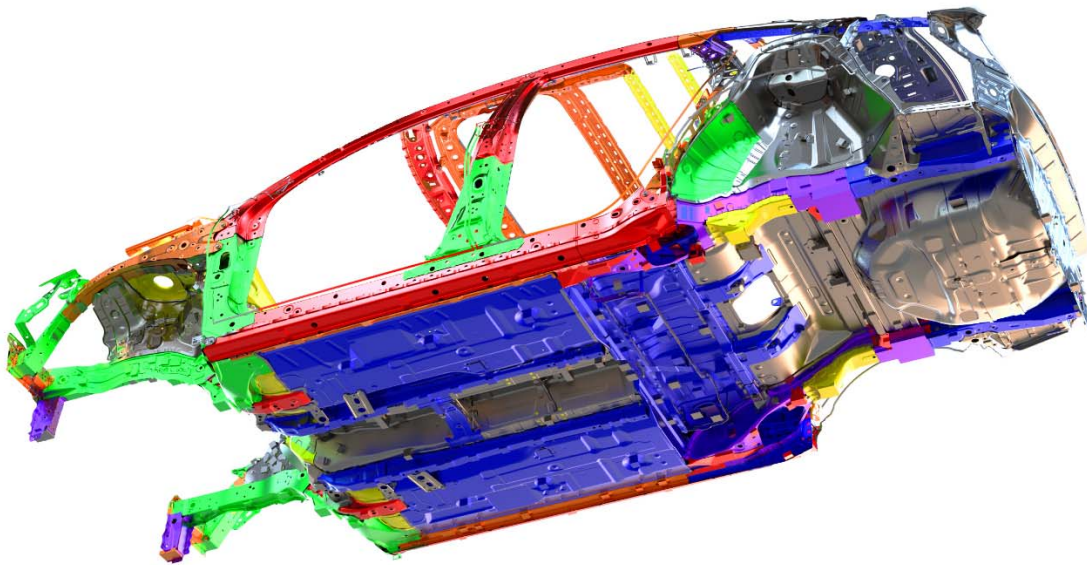
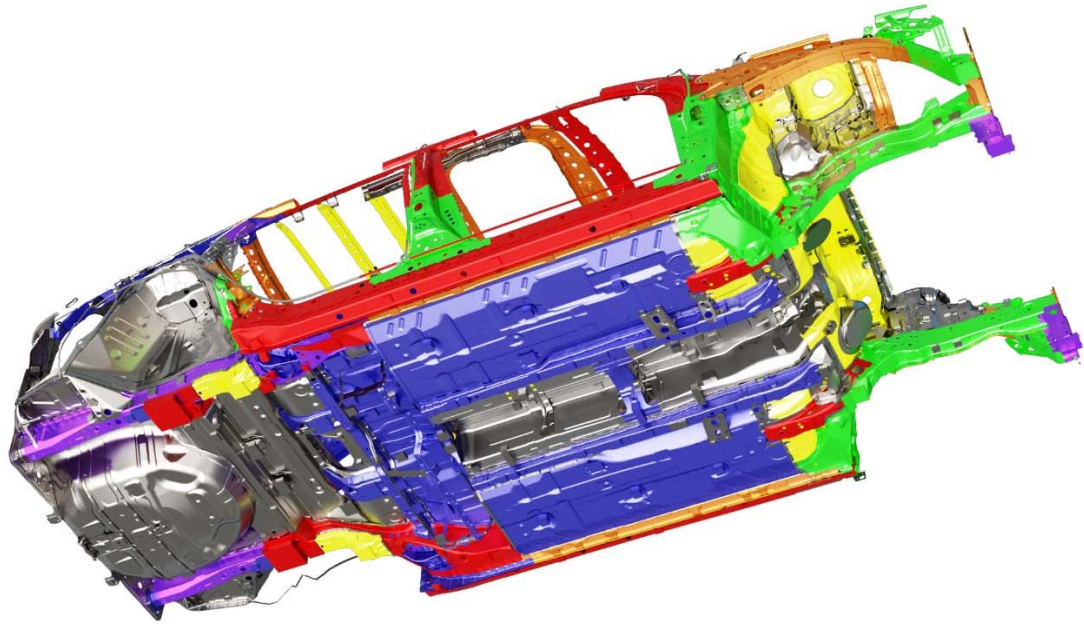

## ALUMINUM PARTS & REPAIRABILITY

The hood of the Civic uses aluminum alloy construction. Minor damage to the aluminum hood may be repaired by body shops that have dedicated aluminum repair facilities and tools.



## RESIN COMPOSITE FRONT BULKHEAD

This vehicle has a front bulkhead assembly constructed of resin composite material.



- The bulkhead design improves engine compartment access during factory assembly and service.
- The cooling fans, radiator, A/C condenser, hood lock, outside air temperature sensor, and related piping/components are attached to the front bulkhead.
- A damaged bulkhead must be replaced.
- For more details, refer to front bulkhead replacement in the body repair manual.

## LASER-BRAZED ROOF PANEL

Laser brazed roof panels require a combination of welding, and the use of adhesives and mechanical fasteners for replacement. Refer to the roof panel replacement procedure for more details.

### WELDING AREAS



### ADHESIVE APPLICATION AREAS

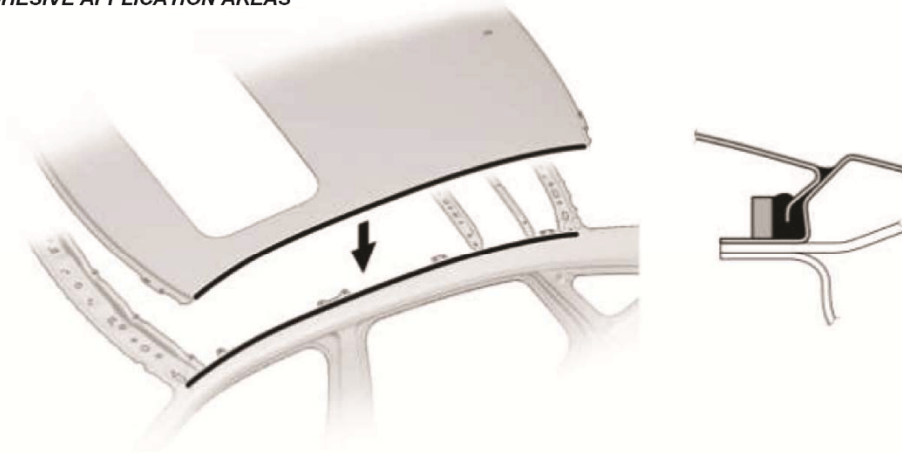

### MECHANICAL FASTENER AREAS

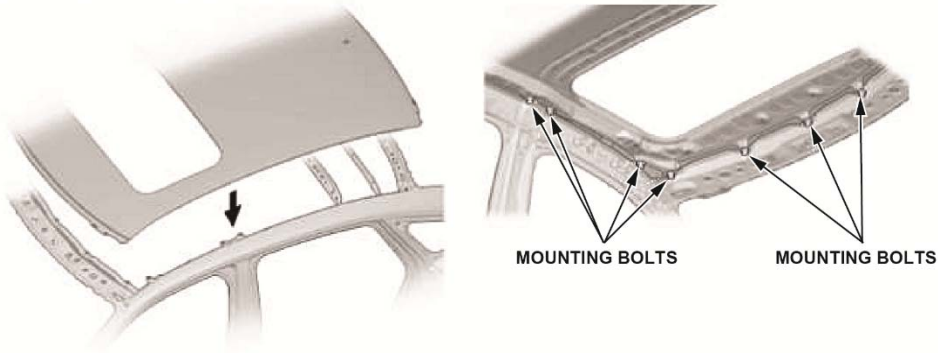

## REAR WHEEL ARCH HEM JOINT

During the replacement of the rear side outer panel, it will be necessary to hem the entire wheel arch using modified commercially available tools, or Honda special tools. Refer to the outer panel side area replacement procedure for additional details including information on how to modify existing hemming pliers.

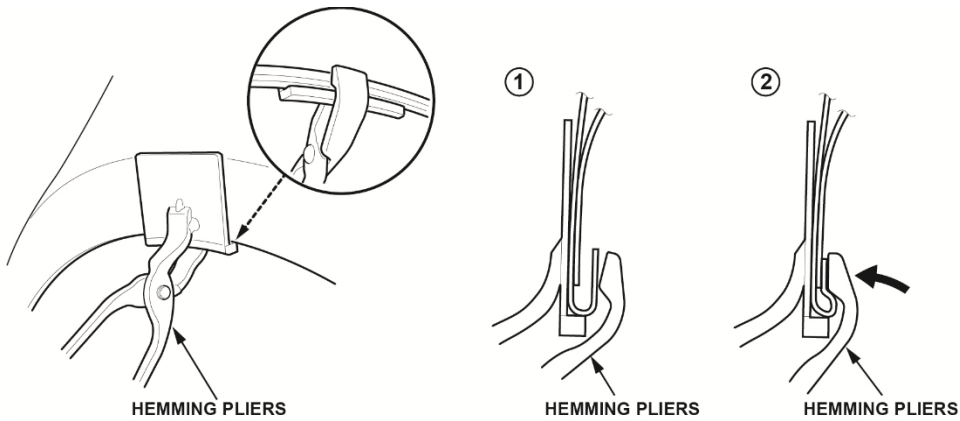

If needed, the Honda Special Service Tool set below is available for purchase from your local Honda dealer.

Tool Number	Description	Note
07AAC-TY2A100	PLIER SET, HEMMING	3-Piece set



## NEW DRIVING SUPPORT SYSTEM

### Multipurpose Camera Aiming

The Civic is equipped with a new driving support system that uses only the multipurpose camera and no millimeter radar unit. The multipurpose camera allows both dynamic and static aiming. Technicians now have the option to do either type of aiming depending on what their repair facility allows, or weather and traffic conditions.

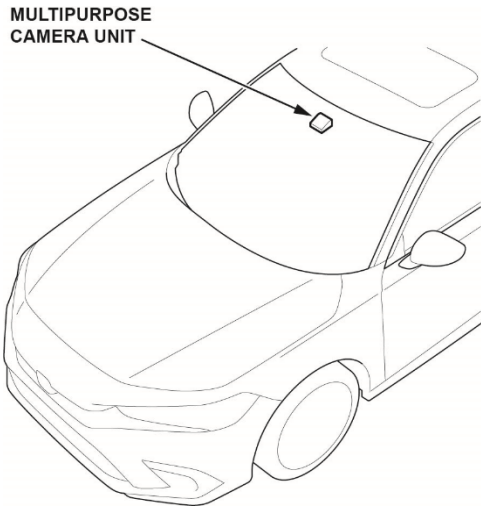

Refer to the following procedures for more details:

- Multipurpose Camera Aiming [Static Aiming]
- Multipurpose Camera Aiming [Dynamic Camera Aiming]

### Blind Spot Information (BSI) Aiming

The Civic is also equipped with a new style blind spot information (BSI) radar units. Unlike other models, the Civic does not require the conventional BSI Radar Unit Aiming Inspection procedure. The system is now capable of self-learning while the vehicle is driven more than **19mph (31km/h)**. However, it is important that the BSI learning status is reset using the i-HDS whenever the following is done:

- After removing and reinstalling one or both of the BSI radar units.
- After repairing the rear panel where the BSI radar unit mounts.
- When any of the following DTCs are stored:
  - B18B8 Left Side BSI Radar Unit Azimuth Off Alignment
  - B1E68 Right Side BSI Radar Unit Azimuth Off Alignment
  - B18BF Left Side BSI Radar Unit Temporary Azimuth Off Alignment
  - B1E6F Right Side BSI Radar Unit Temporary Azimuth Off Alignment

Refer to the following for more information:

- Blind Spot Information (BSI) System Learning Value Reset
- Blind Spot Information (BSI) System Description

NOTE: When the status is reset, the system is limited to **9.8 ft. (3m)** of detection until the self-learning is complete.

## Blind spot Information (BSI) Rear Bumper Repair Templates

The Civic Blind Spot Information radar units behind the rear bumper extend the detection range of previous systems but require extra consideration when repairing the rear bumper.

The radar waves passing through the rear bumper are more affected by the type and location of the repair. Cracks or dents within the radar wave emission range cannot be repaired and will require bumper replacement. Scratches inside or extending into the radar wave emission range will require the whole area to be painted and polished.



To assist technicians in determining where the radar wave emission area is, a printable template is provided in the body repair manual. This template can be taped onto the bumper and will help determine if the bumper can be repaired or will require replacement.

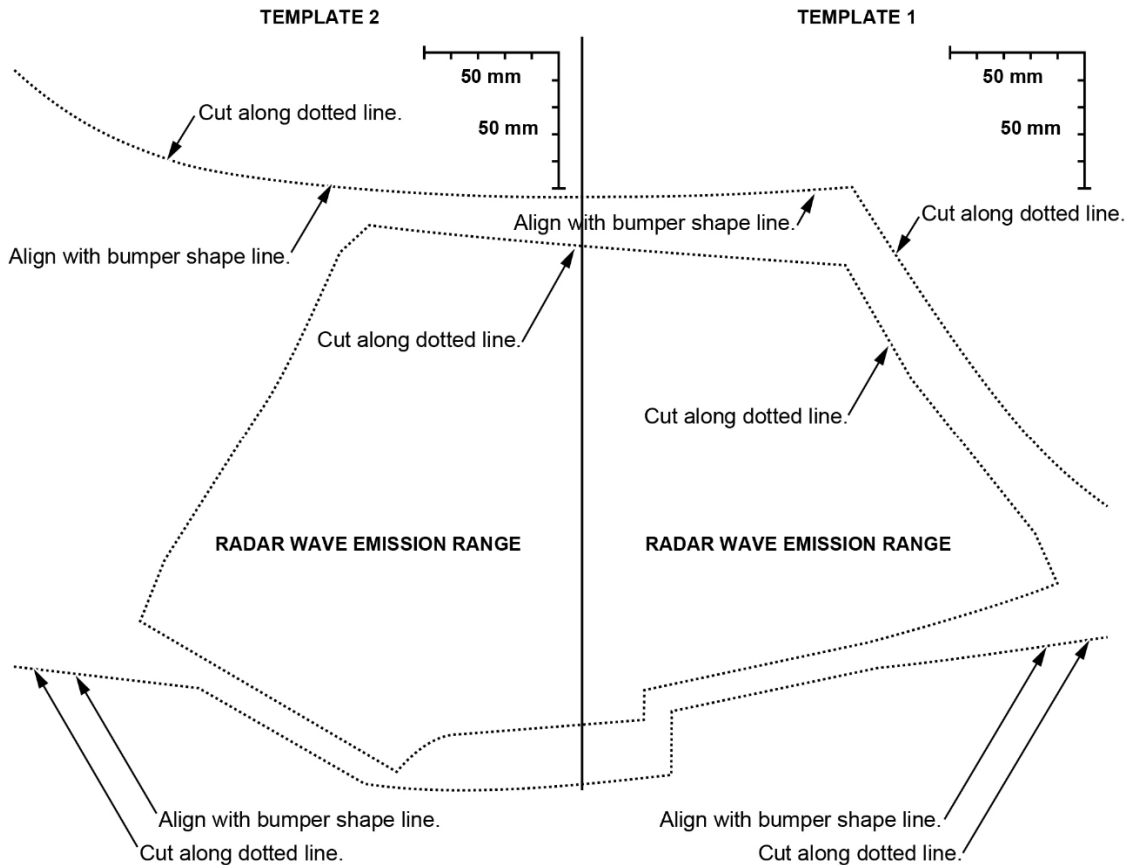

Refer to the following for a printable template and more details:

- Template Printed on Paper for Radar Wave Emission Range [Blind Spot Information System]
- Precautions for Handling Bumpers [Blind Spot Information System]



## SUSPENSION BUSHING TIGHTENING PROCEDURE

To improve ride comfort and avoid excessive twisting of the suspension bushings, the tightening of some specified suspension components must be done at close to vehicle ride height with the driver seated. Depending on the bushing being tightened, the ride height can be simulated on the ground with weight in the vehicle, or the suspension component can be adjusted to ride height position.

Refer to the Tightening Procedure of Suspension Bushing for more detail.

### FRONT SUSPENSION

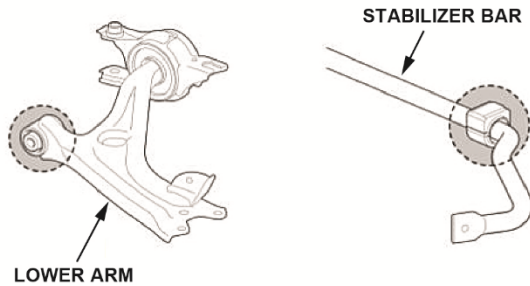

### REAR SUSPENSION

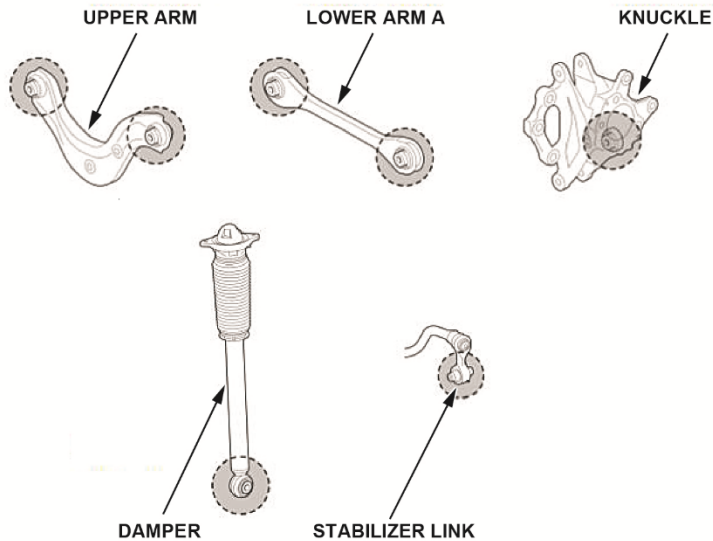

## TRUNK FEATURES

The Civic features an emergency trunk release separate from the trunk latch.

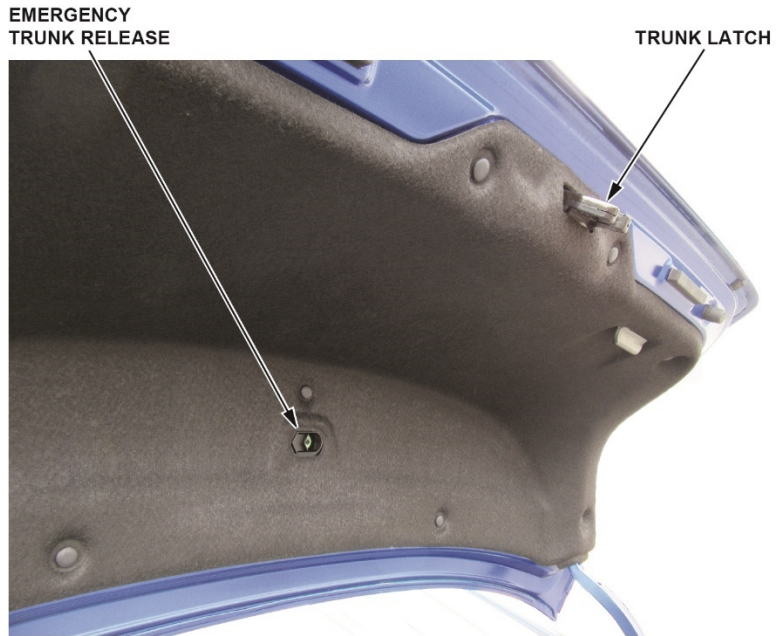

*Touring only.* In addition to the trunk torsion spring, the trunk hinge is supported by a gas-filled damper to allow for one-touch opening.

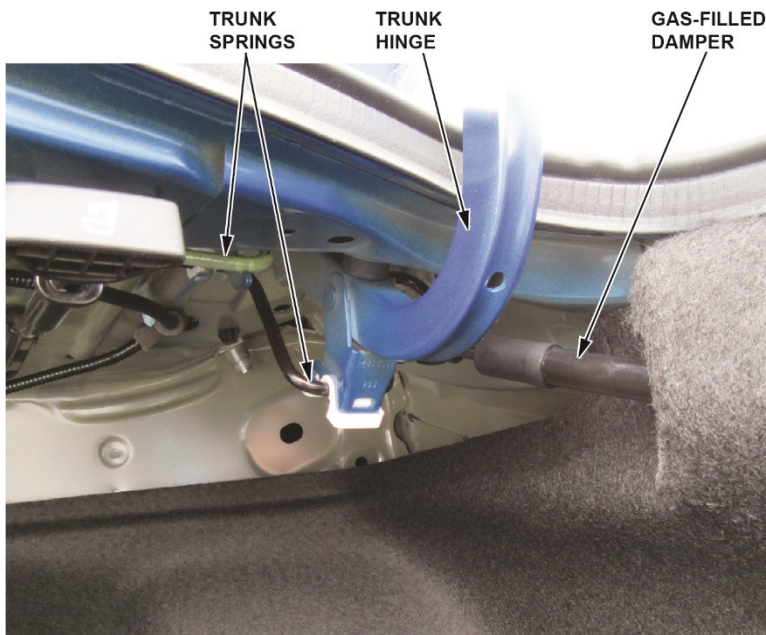

## ECU KEY WRITE

A security key code protocol is being introduced for certain electronic control units (ECUs). This protocol provides secured communication between control units, helping to prevent cyberattacks from outside sources.

When replacing control units like the VSA modulator control unit, you will need to access the **ECU Key Write** application in the i-HDS. For more information, refer to the job aid, *Using the ECU Key Write Application in the i-HDS*.

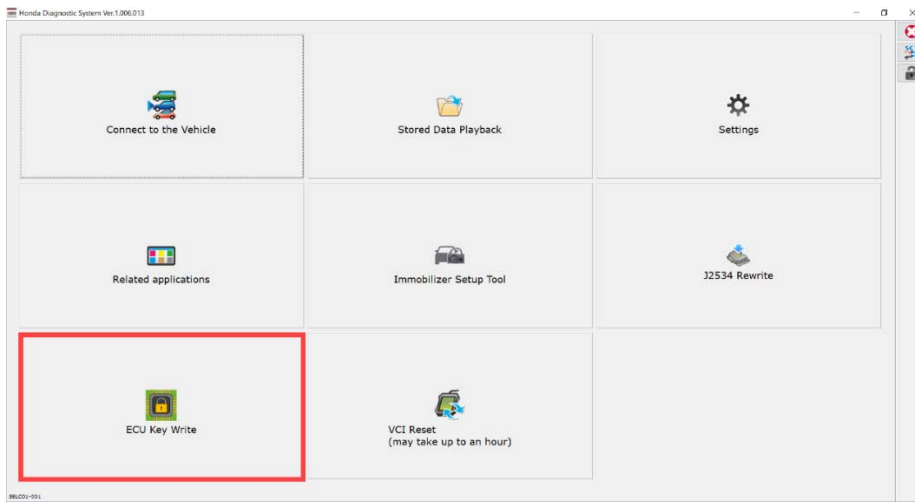

## HYBRID MODELS

New for the 2025 model year, introduces a Hybrid version to the Civic's line up and comes in either 4-door or 5-door models.



## High-Voltage Battery Location

The high-voltage battery is a 72 cell (2 modules), Li-ion battery that is mounted under the rear seats with an output of 262-volts. Simply remove the rear seat assembly to expose the battery. Refer to service information for details.

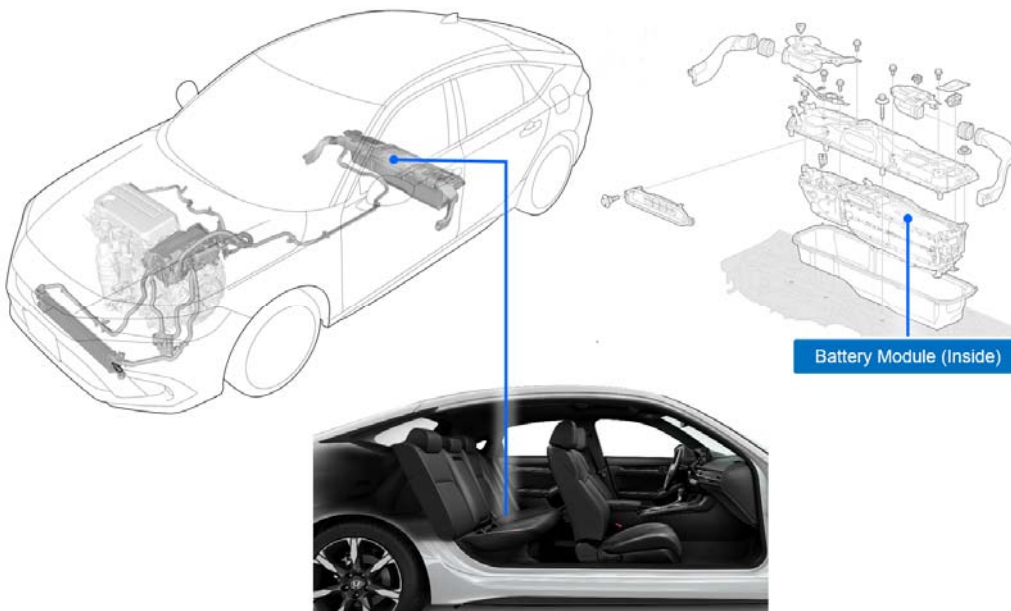

## **High Voltage Safety Resources**

Whenever you do any repairs that requires the removal of high-voltage components, you must shut-down the high-voltage system. Make sure to carefully review and follow the procedures outlined in the following service information topics.

- Electric Powertrain Service Precautions (General safety information for high-voltage handling)
- Electric Powertrain Service Precautions for Service Plug (To safely shut-down the high-voltage)

When handling high-voltage safety, make sure to always wear the proper personal protective equipment (PPE) and safety data sheets (SDS). Refer to job aid, *High-Voltage Battery Storage and Handling* for details.

## **Paint Drying**

High temperature may damage the battery module. When drying paint in a heated paint booth, make sure the temperature does not exceed 149°F (65°C).