

Helping Consumers Keep Their Ford a Ford

Ford has created a campaign to help consumers understand why using OEM parts matters. The new TakeAGoodLook.com helps consumers navigate the collision repair process and get the right insurance policy, the right repairs and the right parts, but it's also intended to be an easy resource for shops to help inform their customers.

Not All Collision Replacement Parts are Created Equal

Most people in the industry know that the right parts for any vehicle are the OEM replacement parts made by the vehicle manufacturer. With so many different aftermarket parts available, Ford realized that people needed to be educated about why the right parts matter.

The goal of this site and campaign is to help consumers be more prepared before an accident even happens. It does this by educating them about how OEM replacement parts are specifically engineered to provide the same quality, durability, fit and finish as the parts made to build the vehicle. As you'll see, the site also goes into the differences between OEM and aftermarket, salvage and reconditioned parts plus the overall collision repair process and the insurance information they need to help keep their Ford a Ford.

Drivers Have the Right to Get the Right Parts

The site focuses now on three main areas:

"At Your Insurance" details questions people need to ask

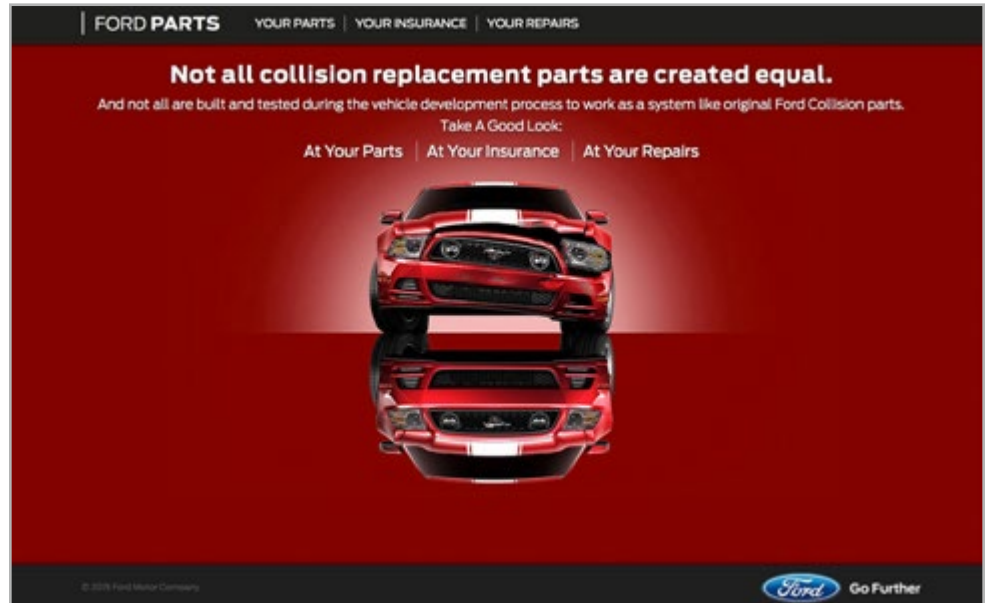

The new website—TakeAGoodLook.com—is part of a new campaign created by Ford to help consumers understand the differences in the various types of replacement collision parts that may be used on their vehicle and the importance of using genuine Ford replacement parts.

their insurers about OEM parts coverage. It also reminds consumers that they have rights when making a claim. Those include:

- Which body shop they use
- Which parts are used to replace damaged parts

- They don't have to release their vehicle to a body shop before they are ready
- They should get estimates completed before starting any repairs

Continued on page 2

2015 Ford F-150 Instruction Sheets Now Available

As the all-new 2015 Ford F-150 begins hitting the road in significant numbers—and finding its way into collision repair shops—Ford is helping repairers get ready by rolling out 51 unique repair instruction sheets. Available at no charge through the Inter-Industry Conference on Auto Collision Repair

(I-CAR), the sheets provide important detailed instructions on part removal and installation procedures for all key areas of the vehicle.

"Many aspects of this truck were designed from the very beginning with repairers in mind," said Gerry Bonanni, Ford senior damageability engineer. "With a high-strength steel frame and a cab and pickup box of high-strength, military-grade, aluminum alloys, the truck features an upstream design that will enhance and improve its overall reparability. A large component of that is the development and inclusion of the 51 instruction sheets, which call out repairs in detail and provide repairers with a unique step-by-step repair process to help them restore the vehicle to proper working order."

The instruction sheets—which come packaged with any part that needs to be installed with rivets and/or adhesives—also provide a wealth

Continued on page 5

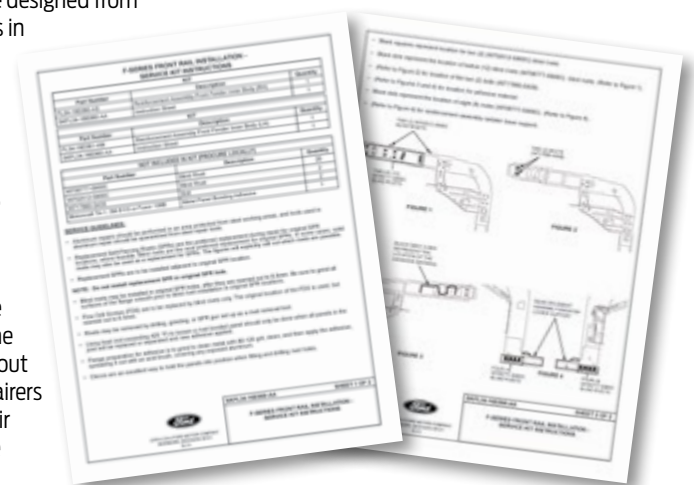

In this issue ...

- Ford Updates Refinish Info..... 2
- Q&A with Gerry Bonanni..... 3
- Inside the Industry 3
- Legal / Legislative Update 4
- Events Calendar..... 5

Consumer Awareness Campaign

Continued from page 1

“At Your Parts” defines the different types of OEM and aftermarket parts available to help drivers be better-informed consumers, including a robust list of non-OEM parts that might show up on an estimate or invoice and how they differ from one another:

- A/M – Aftermarket/Automotive replacement parts
- QRP – Quality Replacement Parts
- CP – Competitive Parts
- LKQ – Like Kind and Quality
- Salvage
- Reconditioned – Recon
- Recycled

“At Your Repairs” lists tips for finding the right repair shop to perform collision repairs. Those include:

- Looking into the Ford National Body Shop Network
- Asking their dealer if they have a collision shop and if they use OEM parts
- Asking about training, certifications and qualifications
- Knowing that no one—not even their insurance company—can force them to go to a specific shop

Through this abbreviated version of the site, you can



The TakeAGoodLook.com website is divided into three sections, giving consumers a wealth of information regarding insurance options, the different kinds of parts available for repairs as well as the repairs themselves. The goal is to help inform consumers to get the highest-quality vehicle repairs possible.

see how Ford is working to help empower consumers by arming them with important information that any driver should know. Be sure to check out the new



campaign from Ford and visit TakeAGoodLook.com, then check back often for new content throughout the year.

Ford Updates Refinish Information

Ford Motor Company has updated some of the supplementary information it provides in connection with its approved paint systems for refinish, and it's urging all repairers to make sure they're aware of the latest guidelines and recommendations, and have access to all current applicable paint company technical data sheets.

The following paint systems have passed Ford's series of rigorous and comprehensive technical evaluations—known as aftermarket refinish specification WSS-M2P-100-D—to earn approval for use on all Ford vehicle brands globally:

AkzoNobel Paint Systems

- Sikkens
- Lesonal

Axalta Paint Systems

- Axalta
- Spies Hecker
- Standox

BASF Paint Systems

- Glasurit
- RM

PPG Paint Systems

- Nexa
- Autocolor

Sherwin Williams Paint Systems

- Sherwin Williams
- Martin Senour

Valspar Paint Systems

- DeBeer

In the ongoing effort to provide repairers with all the information necessary to make proper repairs, Ford has issued the following key supplementary updates:

Catalyzed Basecoat: The recommendations in these systems call for the use of a catalyst in the basecoat. To match the OEM durability levels in all performance tests, the addition of the hardener/catalyst was critical to the durability of the paint—the difference is dramatic. **Ford requires this for all warranty paint repairs.**

Panel Application of Clear Coat: The guidelines for the usage of these materials do not recommend or allow partial clear-coat blending. While the color/basecoat(s) may be blended, the only Ford-approved paint repair is full-panel clear-coat application.

Aluminum Panel Repairs: The paint company technical data sheets and their best practices information must be referred to and followed when working with the repair of bare aluminum substrates. Recommendations may vary, and the paint company information is specific to that system. When preparing a new



Ford service part, try to maintain the factory applied E-coat as much as possible.

Ford strongly recommends repairers print all technical data sheets and keep them handy for quick reference in addition to the paint company manuals. Dealers can find all the information on FMCDealer.com, while independent repairers should contact their local Ford or Lincoln dealer, the paint company in question, or the Ford Collision Parts Hotline at cphelp@ford.com.

For additional information on Ford-approved refinish paint systems or repairs in general, contact Gerry Bonanni, Ford's senior damageability engineer, at (313) 317-9000, or the Collision Parts Hotline at cphelp@ford.com.

Q&A With Ford Senior Damageability Engineer Gerry Bonanni



How we thought the show went last year:

NORTHEAST® 2014 provided us with a great venue to promote the repairability aspects of the new F-150 as well as speak directly with repairers about many Ford approved repair procedures. We were very pleased with the show's attendance, which is why we're returning in 2015.

What we are looking for this year:

Now that the truck is on the road, we are looking for real-life feedback from body shop technicians about the vehicle's repairability and Ford-approved repair procedures.

Why we specifically chose the NORTHEAST show:

We thought it was important to be at the forefront of the truck's launch and answer technicians' questions face-to-face. NORTHEAST® is a great opportunity to convey that information to them directly.

How we feel the truck and its repair information have been accepted:

While aluminum isn't a new material for repairers to work with, the new F-150 represents a quantum-leap in terms of overall usage of the material. The 2015 F-150 was designed directly with the repairer in mind, and we've had very positive feedback from repairers once we introduce them to many of the new repair techniques available on the truck.

Ford engineers Gerry Bonanni (right) and Larry Coan (below) led several presentations on the repairability options on the new 2015 F-150 at SEMA last November. Ford's presentations—which were among the most well-attended at the show—detailed the approved repair procedures, highlighting the importance of using the proper tools and equipment, and practicing good shop hygiene to prevent cross-contamination of steel and aluminum particles.



FCSD Brings 2015 F-150 Repair Info to the SEMA Show



INSIDE THE INDUSTRY

Collision Repair Issues Make National News

Spurred by numerous similar lawsuits filed by shops alleging more than two dozen insurers have acted illegally to reduce costs, CNN aired a nearly 11-minute story on the collision industry February 11th. The investigative report featured interviews with Louisiana Attorney General Buddy Caldwell and Mississippi Attorney General Jim Hood, along with U.S. Senator Richard Blumenthal, formerly Connecticut's attorney general.

Study Finds Insurance Rates Spike After a Claim

The cost of auto insurance increases an average of 41 percent after making a single claim. That's up from 38 percent last year, according to the second annual report released by InsuranceQuotes.com. The insurance rate research site says making a second claim results in an average cost 93 percent higher than that for a claim-free driver. Motorists in

Massachusetts saw the highest average premium hike after the first claim, at 76 percent, followed by California (75 percent) and New Jersey (62 percent).

LOR Jumps in Q4

The U.S. length of rental (LOR)—used as a measure of repair cycle time—rose to 11.4 days during the fourth quarter of last year, up from 11.1 during the same period in 2013, and the highest Q4 figure in the last five years. That's according to Enterprise Rent-A-Car, which reports non-drivable repairs increased 0.5 days versus a year ago, while drivable repairs inched up just 0.2 days. The Mountain, Northeast and Southwest regions each reported the highest LOR at 12.2 days, while the Northwest saw the lowest at 10.3.

NACE Expecting a Bigger Show This Year

The Automotive Service Association says it anticipates this summer's NACE/CARS Expo will be 50 percent bigger than last year's event. The show

is returning to Detroit for a second consecutive year, and ASA says Ford, Chrysler, General Motors, Honda and Nissan have each committed to be back as well. The NACE/CARS show floor will be open July 23 – 25, once again as part of Industry Week, which will include meetings and events held by the Collision Industry Conference, Collision Repair Education Foundation, National Auto Body Council and other groups. Go to NACEExpo.com for more information.

VMT Remains on the Rise; Vehicle Fatalities Decline

The Federal Highway Administration reports the number of vehicle miles traveled (VMT) nationwide in November hit 241 billion, up 1.1 percent—or 2.5 billion miles—compared to November 2013. It marks the ninth consecutive monthly VMT increase vs. 2013, after declines in January and February of last year.

Continued on page 4

Crash Parts Legislative Updates

Collision-repair related legislation has been introduced or carried over in several states and Congress so far this year. Here's a rundown:

GOV. ENTITY	BILL NUMBER	BILL STATUS AND DESCRIPTION
IL	H 3406	Introduced 2/26/15. Changes term "aftermarket crash part" to "aftermarket part," redefining it to include exterior or interior nonmechanical sheet metal or plastic parts, as used in non-OEM parts disclosure requirement.
	H 3407	Introduced 2/26/15. Prohibits insurers from requiring shops utilize specific products, vendors, distributors, manufacturers or suppliers.
IA	H 287	In comm. Makes installation of counterfeit or non-functioning airbags punishable by up to two years in prison.
MN	S 135	In comm. Prohibits insurers from requiring a loss adjustment at a particular shop.
MS	S 2236	Died. Changes law requiring an insurer to add the repair shop to the claim check to only include checks of more than \$2,000.
	S 2235	Died. Limits maximum labor rate collision shop could charge to no more than 20% above national average.
	S 2257	Died. Anti-steering measure.
MT	S 132	Tabled in comm. Requires insurers to disclose types of parts to be used in a repair at time of selling the policy.
NJ	A 3364	In comm. Prohibits manufacture, sale or installation of counterfeit or nonoperational air bags. Same as S 2174.
NY	S 30	In comm. Requires shops and insurers use OEM parts for first three years or length of new-vehicle warranty. Afterward requires disclosure and consent for all parts and that insurers pay extra labor to install non-OE if not the easiest fit.
	S 1207	In comm. Prohibits insurers from requiring shops use a certain vendor or process for materials.
	A 1537	In comm. Prohibits insurers from using price caps on labor or materials without negotiating with customer first.
OR	H 2496	In comm. Requires shops to return all parts replaced during repair to the customer.
RI	H 5484	In comm. Expands definition of aftermarket parts to include all replacement parts, not just body parts.
	H 5491	In comm. Establishes two levels of collision repair license.
VT	H 362	In comm. Prohibits requiring use of aftermarket parts for two years or 30,000 miles; requires disclosure of aftermarket parts and that they be like, kind and quality to OE parts in terms of fit, quality and performance.
WV	H 2045	In comm. Limits personal liability for repair costs from deer strikes to \$200.
US	HR 1057	Introduced 2/25/15. Reduces length of crash parts design patents from 14 years to 30 months. Opposed by ASA.
	S 565	Introduced 2/25/15. Encourages use of remanufactured parts in repair of federal vehicle fleet.

LEGAL UPDATE

Cost-Reduction Suits Consolidated in Florida

More than 20 similar lawsuits accusing dozens of insurers of illegally manipulating labor rates and compensation have now been consolidated with a U.S. District Court in Florida. The cases have been filed by collision shops in 18 states—AL, AZ, CA, FL, IL, IN, KY, LA, MI, MS, MO, NJ, OH, PA, TN, VA, VT & WA—and include a suit against State Farm brought by the Louisiana attorney general's office.

Judge Allows Karmer Deposition

A U.S. District Court judge has ruled plaintiffs suing State Farm over its alleged role in the 2004 election of Illinois Supreme Court Justice Lloyd Karmer can depose him after all. A previous ruling had limited the plaintiffs to submitting up to 20 questions in writing. Karmer voted to overturn the \$1.05B judgment against the insurer in the 1999 *Avery v. State Farm* non-OEM parts case soon after his election to the court. He was narrowly re-elected to a second term last year.

The Hartford Appeals CT Ruling

The Connecticut Supreme Court heard arguments in January in The Hartford's appeal of a \$34.7M judgment against it. The Auto Body Association of Connecticut and a number of its member shops successfully accused the insurer of unfairly suppressing labor rates and steering in 2009, and were awarded \$14.7M in compensatory damages. A state Superior Court awarded another \$20M in punitive damages in 2013.

INSIDE THE INDUSTRY

Continued from page 3

At the same time, the National Highway Traffic Safety Administration says the number of deaths on the nation's roads in 2013 fell to 32,719, a drop of 3.1 percent from 2012 and 25 percent fewer than 2004.

SCRS Launches Industry News Site

The Society of Collision Repair Specialists has unveiled a new website aimed at providing collision repairers with the most up-to-date news and breaking industry developments. "The site features stories from a variety of different sources and on different topics," said Aaron Schulenburg, executive director of SCRS. The website, which will also have a downloadable app for Smartphones, is located at www.repairerdrivenews.com.

Feds Recommend New Braking Systems

NHTSA has announced it will add two automatic emergency braking technologies to its list of recommended safety features. Crash imminent braking (CIB) systems can automatically apply the vehicle's brakes when the system anticipates a crash, while dynamic brake support (DBS) systems can supplement the driver's braking effort to help mitigate or avoid a crash. The agency says one-third of all police-reported crashes involve a rear-end collision, and that in many of those cases the driver either does not apply the brakes fully or at all prior to impact.

Report Finds AVs to Hit the Road in the Next Decade

Partially autonomous vehicles (AVs) could be on the road in significant numbers by 2017. That's according to a new report released by the Boston Consulting Group, which finds that keeping vehicles

secure from cyber attacks, liability concerns and other issues still need to be overcome before widespread adoption of AVs can occur. Assuming those issues are resolved, the study expects vehicles with an urban autopilot will appear by 2022 and fully autonomous vehicles will be available by 2025.

CIF Helps Soldier in Need

The Collision Industry Foundation has announced the donation of tools and a custom tool box to a soldier who recently returned from deployment overseas. Sterling Keith, a collision repair technician who served four tours of duty in Iraq with the U.S. National Guard and Navy, had his collision tools stolen during his deployment. The CIF made the presentation to Keith and his wife at the January Collision Industry Conference in Palm Springs, Calif. More information is available at CollisionIndustryFoundation.org.

2015 Ford F-150 Instruction Sheets Now Available

Continued from page 1

of other important information, including part numbers and descriptions, the number of blind or self-piercing rivets needed and the proper Ford-approved adhesives to use. In addition, diagrams on the instruction sheets show the precise placement of the rivets and adhesives in the repair.

The instruction sheets are segmented by Regular Cab, Super Cab and Crew Cab versions of the truck, and cover six categories:

- Radiator Core Support and Front Upper Rail
- Cowl and Dash
- Roof and Roof Rails
- Doors and Cab Side (Outer Uniside, Pillars, Rocker Panel)
- Floor Pan, Floor Crossmembers and Cab Rear Panel
- Box

“It was important to convey to repairers that the aluminum repair procedures approved for

the truck are very similar to steel repair procedures, just with different techniques,” Bonanni said. “One way we accomplished that is through the instruction sheets, which provide more than the usual repair information to help technicians lay out their overall repair strategy up front.”

It’s the first time Ford has released comprehensive collision repair instruction sheets to I-CAR on this scale through the RTS Portal, which highlights the value of I-CAR’s ongoing industry/OEM linking pin activity focused on making critical collision repair information available and accessible to the industry.

“It is important for collision repair professionals to have the information readily available to repair this popular vehicle,” said Jason Bartanen, director of industry technical relations for I-CAR. “Working with Ford to provide this information

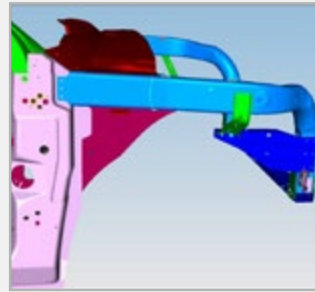

via the RTS Portal improves industry access to the information required to support complete, safe and quality repairs.”

I-CAR also offers more in-depth training on the repair of the new F-150 through its structural repair course (# FOR06) and an aluminum welding and certification

course (# WCA03), both of which were created with Ford.

The 2015 Ford F-150 collision repair instruction sheets can be accessed through the I-CAR Portal at i-car.com/rts.

For questions on repairs to the 2015 F-150, or any other Ford Motor Company vehicle, contact Gerry Bonanni at (313) 317-9000 or the Ford Collision Parts Hotline at cphep@ford.com.

Ford Unveils Next-Generation Steering Technology

Ford Motor Company is bringing to market a new generation of steering technology designed to help make vehicles easier to maneuver at low speeds and more agile and responsive at higher speeds.

Adaptive Steering changes the ratio between the driver’s actions at the steering wheel—and how much the front wheels turn. Until now this has been a fixed ratio, but with Ford’s new Adaptive Steering, the steering ratio continually changes with vehicle speed, optimizing the steering response in all conditions.

At lower speeds, such as when pulling into a parking space or maneuvering in tight quarters, the new system makes the vehicle easier to turn,

as it dials more steering into the road wheel. At highway speeds, the system further optimizes steering response, enabling the vehicle to react more smoothly and precisely to driver input.

Ford’s system doesn’t require any change to the vehicle’s traditional steering system, but instead uses a precision-controlled actuator placed inside the steering wheel. The actuator—an electric motor and gearing system—can essentially add to or subtract from a driver’s steering inputs. The result is a better driving experience at all speeds, regardless of vehicle size or class.

Adaptive Steering is available on select Ford and Lincoln vehicles beginning this year.



Adaptive Steering changes the ratio between the driver’s input at the steering wheel and the amount the front wheels move.

INDUSTRY EVENTS CALENDAR

2015

- April 7 SCRS Open Board Meeting
Atlanta, GA www.scrs.com
- April 8 – 9 Collision Industry Conference – General Meeting
Atlanta, GA www.ciclink.com
- April 22 – 24 Auto Glass Safety Council Technician Training
Irvine, CA www.agrass.org
- June 19 – 21 ASA-Arizona Automotive Training Expo
Chandler, AZ www.asaaz.org
- July 20 SCRS Open Board Meeting
Detroit, MI www.scrs.com

- July 21 – 22 Collision Industry Conference – General Meeting
Detroit, MI www.ciclink.com
- July 22 Collision Repair Education Foundation Annual Golf Outing
Detroit, MI www.cref.org
- July 23 – 25 International Autobody Congress & Exposition (NACE)
Detroit, MI www.naceexpo.com
- Sept. 20 – 23 Fix Auto National Conference
Ojai, CA www.fixauto.com
- Nov. 4 – 5 Collision Industry Conference – General Meeting
Las Vegas, NV www.ciclink.com

- Nov. 3 – 5 Automotive Aftermarket Products Expo (AAPEX)
Las Vegas, NV www.aapexshow.com
- Nov. 3 – 6 Specialty Equipment Market Association (SEMA) Show
Las Vegas, NV www.semashow.com

2016

- Jan. 13 – 15 Collision Industry Conference – General Meeting
Palm Springs, CA www.ciclink.com

Get it right.



From the source.

Ford and Lincoln Dealers are the one-stop source for all of your collision repair needs.

Not only are they a great source for technical and repair information, their Ford Motor Company Genuine Parts can help your body shop reduce cycle time, improve relationships with insurance companies and satisfy customers. So call your local Ford or Lincoln Wholesaling Dealership today for all your Genuine Parts needs.



SHARE YOUR THOUGHTS

The purpose of **On Target** is to provide Ford and Lincoln dealership parts departments and independent collision repair shops with the general and technical information needed to deliver efficient, high-quality repairs to Ford, Lincoln and Mercury vehicle owners. In addition, information on parts wholesaling policies and procedures, and collision repair industry activities will also be featured.

On Target is scheduled to be published three times a year.

Your comments and article ideas are welcome. You can contact **On Target** through e-mail at: cphelp@ford.com.

Additional copies of **On Target** are available through Ad Creator or FMCDDealer.com. Independent collision repair shops should contact their Ford or Lincoln wholesaling dealer. **On Target** is also available free of charge at Motorcraft.com under technical resources / quick guides.

On Target

Produced for Ford and Lincoln wholesaling dealers and their collision repair customers.

Editor

George Gilbert

Contributors

Chris Caris Kim Jennings
Steven Lubinski Andrea Presnell



FORD PARTS

Dealership Information

Crash Parts Order Form

Use this form to provide us with the information necessary to make certain we deliver the right parts on time ... the first time!

The information below can be found on the certification label located on the driver's-side door jamb.

If the vehicle is damaged in this area provide us with the Vehicle ID# located on the driver's-side front corner of the dashboard.

VEHICLE ID#	(Need all 17 Digits)				
TRIM CODE		YEAR		DAMAGE AREA (Circle)	
MLDG. CODE		MAKE		FRONT	REAR
BODY CODE		PHONE:	()	LEFT SIDE	RIGHT SIDE
CONTACT:		SHOP:		UNDERBODY	LEFT / RIGHT

2015 FORD F-150

Date Ordered:	PARTS ORDER	Date Needed:
---------------	--------------------	--------------

QUANTITY	PART NUMBER / PART DESCRIPTION

NOTE: Refer to vehicle diagrams for part identification and numbers.

Front Bumper

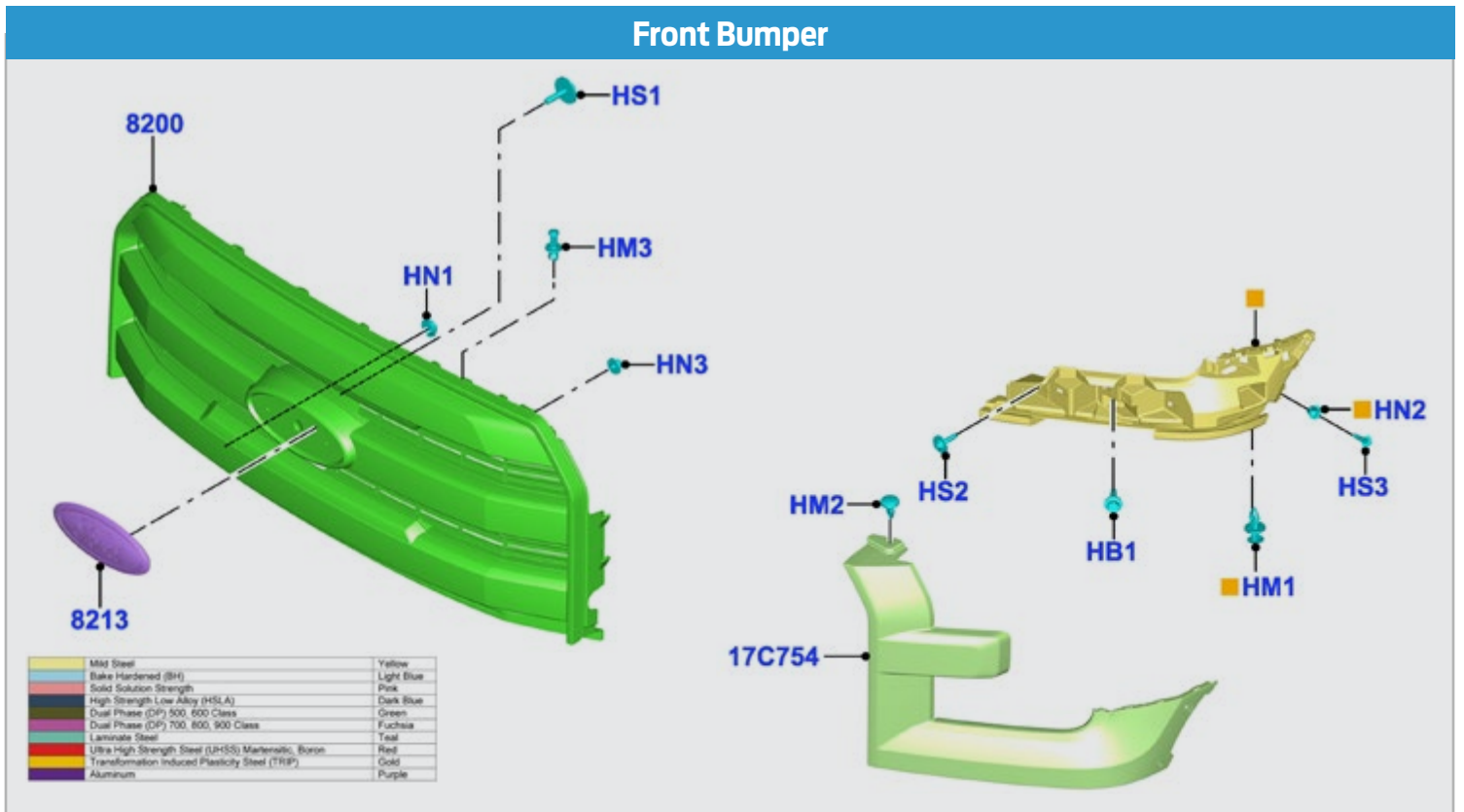

Hood

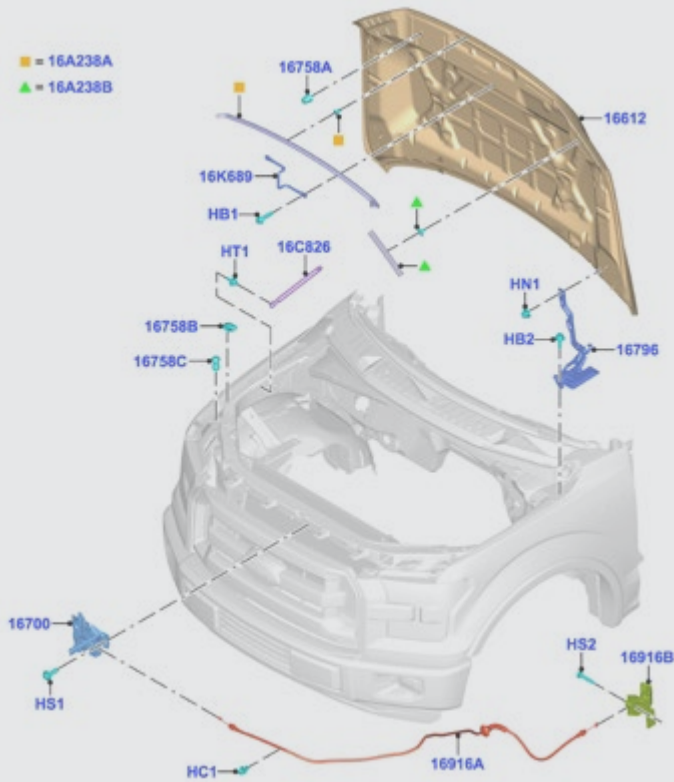

Front Apron

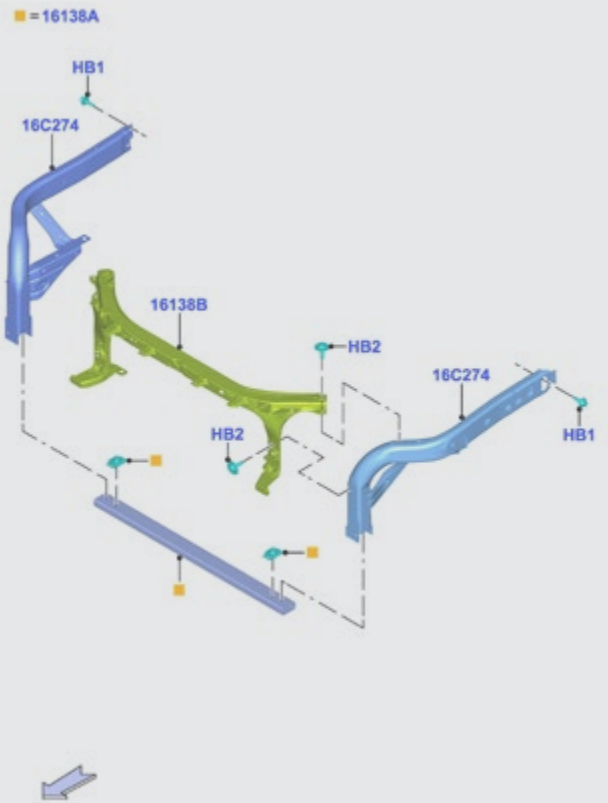

Inner Panels

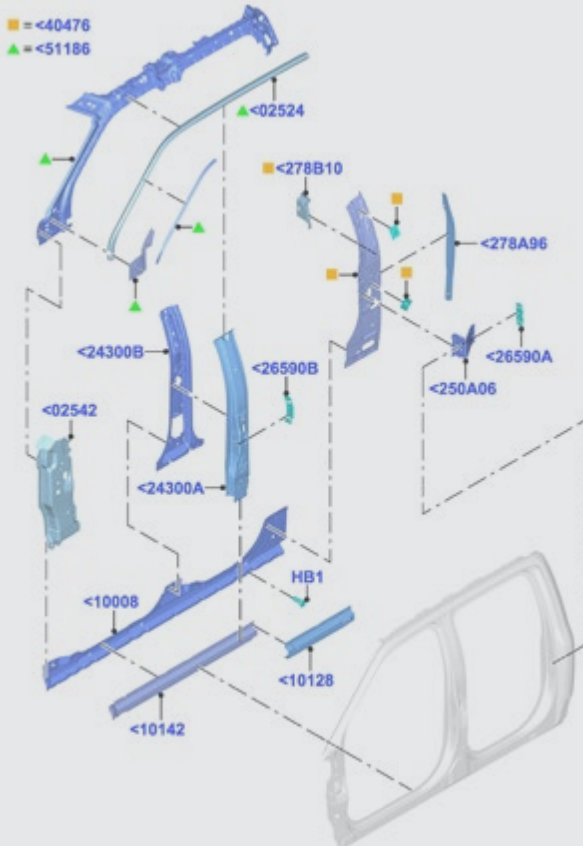

Rear Bumper

