



Information for First & Second Responders Emergency Response Guide For Vehicle:

Li-ion

2017–22 Acura NSX
2-Door Coupe Hybrid Electric Vehicle

NSX



Version 1

This guide has been prepared to assist emergency response professionals in identifying a 2017–22 Acura NSX and safely respond to incidents involving this vehicle.

Copies of this guide and other emergency response guides are available for reference or downloading at <https://techinfo.honda.com>.

For questions, please contact the following:

USA: Your local Acura dealer or Acura Automobile Customer Service at **(800) 382-2238**.

Central America: Your local Acura dealer or distributor.

Acura wishes to thank emergency response professionals for their concern and efforts in protecting Acura clients and the general public.



Contents

1. Identification / Recognition	Page 04
2. Immobilization / Stabilization / Lifting	Page 09
3. Disable Direct Hazards / Safety Regulations	Page 12
4. Access to the Occupants	Page 15
5. Stored Energy / Liquids / Gases / Solids	Page 19
6. In Case of Fire	Page 21
7. In Case of Submersion	Page 22
8. Towing / Transportation / Storage	Page 23
9. Important Additional Information	Page 33
10. Explanation of Pictograms Used	Page 39

All 2017–22 Acura NSX models are equipped with a hybrid powertrain system and no special markings or emblems are applied to the exterior of the vehicle.

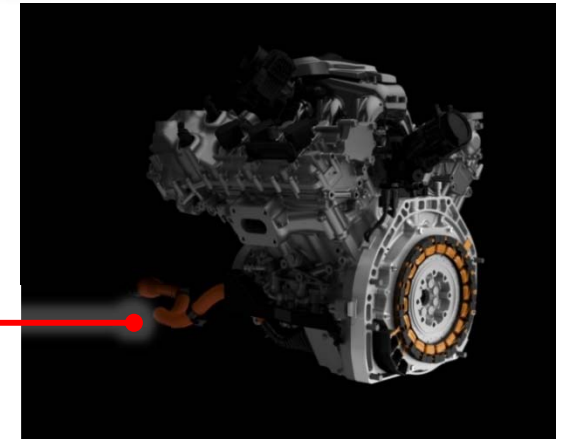
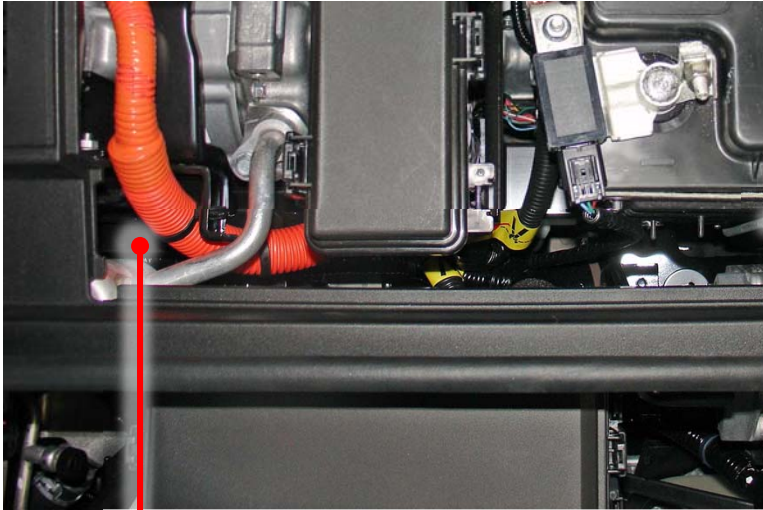

Underneath the vehicle and the hood, the Acura NSX can be identified by easy-to-identify, heavy-duty orange cables. These cables are purposely routed through areas away from the usual cut points.

The Acura NSX can also be identified by inspecting the VIN at the three locations shown below.

The characters 4 thru 6 of the VIN will show **NC1** indicating that it is an Acura NSX.

19U **NC1** *****000001



VIN plate located on the lower-right corner of the front windshield



Stamped into the floor panel in front of the passenger's side seat under a plastic panel marked **FRAME NUMBER**



Printed on the VIN label on the driver's side doorjamb

Warning Labels

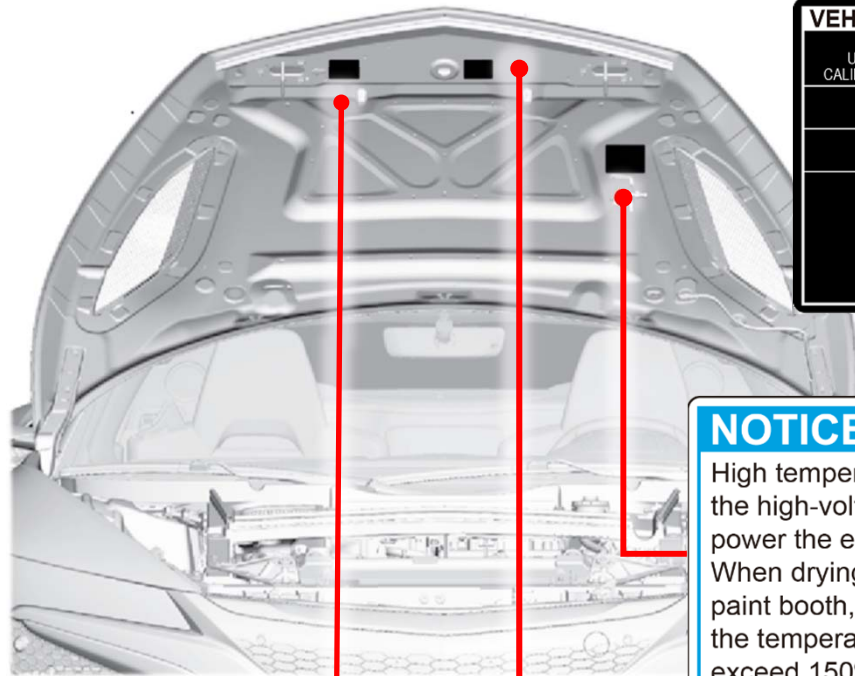

VEHICLE EMISSION CONTROL INFORMATION		
CONFORMS TO REGULATIONS: 2018MY HEV		
U.S. EPA: IT3B125 LDV	OBD: CA II	FUEL: GASOLINE
CALIFORNIA: ULEV125 PC	OBD: CA II	FUEL: GASOLINE
2WU-TWC, 2TWC, 2WR-HO2S, 2HO2S, 2TC, 2CAC, SFI, DFI		
GROUP : JHNV03.5CH4 EVAP : JHNV03.5CH4		
3.5L HONDA MOTOR CO., LTD.		
ACURA		58G-A05

INFORMATION

- THE FACTORY INSTALLED LONG-LIFE COOLANT MUST BE REPLACED ACCORDING TO MAINTENANCE MINDER SUB CODE 5, OR AT 10 YEARS WHICHEVER COMES FIRST. THEREAFTER EVERY 5 YEARS.
- WHEN ADDING OR REPLACING THE COOLANT, ALWAYS USE Acura RECOMMENDED GENUINE LONG-LIFE ANTI-FREEZE / COOLANT TYPE 2. THIS COOLANT IS PRE-MIXED WITH 50% DISTILLED WATER. IT DOES NOT REQUIRE ANY ADDITIONAL MIXING.
- NEVER DILUTE THE COOLANT, OR THE LIFE OF THE ENGINE MAY BE SERIOUSLY SHORTENED.
- CHECK OR ADD THE COOLANT AT THE RESERVE TANK, NOT THE RADIATOR.
- FOR FURTHER INFORMATION ON THE COOLING SYSTEM, READ THE OWNER'S MANUAL OR CHECK WITH YOUR Acura DEALER.

NOTICE

High temperature may damage the high-voltage battery used to power the electric motor. When drying paint in a heated paint booth, make sure the temperature does not exceed 150°F(65°C).

CAUTION

CAUTION SYSTEM CONTAINS REFRIGERANT R-134a UNDER HIGH PRESSURE. TO BE SERVICED ONLY BY QUALIFIED PERSONNEL. Follow Instructions in the service manual.

AIR CONDITIONER SYSTEM

REFRIGERANT : R-134a (SAE J639)

REC. CHARGE : MAX 0.505kg MIN 0.455kg

OIL TYPE : ND-OIL11 (POE)

T6N Honda Motor Co., Ltd.

NOTICE

If this vehicle is not driven for 3 months or longer, the high-voltage Lithium-ion battery can be permanently damaged due to prolonged low state of charge. To maintain an adequate charge level, drive the vehicle for more than 30 minutes at least once every 3 months.

LITHIUM-ION BATTERY DISPOSAL INFORMATION

A large high-voltage Lithium-ion battery located behind the seat. The high-voltage Lithium-ion battery requires a special disposal process. Contact American Honda at 1-800-555-3497 for handling and disposal information.

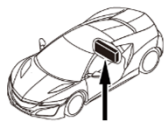

High-voltage Lithium-ion battery

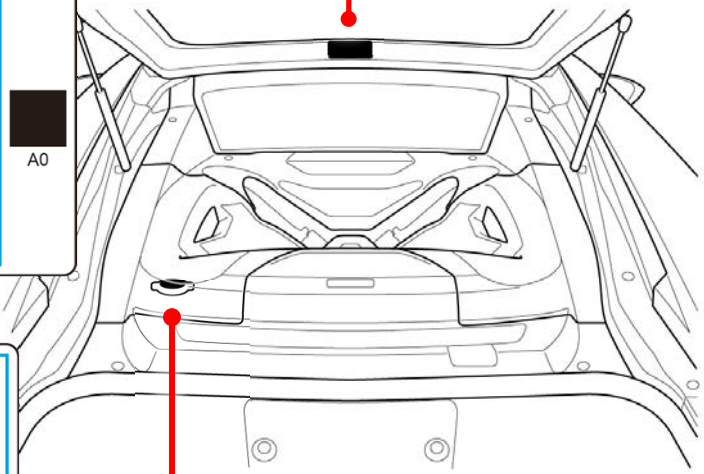

DANGER WARNING

危険 危険

NEVER OPEN WHEN HOT. Hot coolant will scald you. N'OUVREZ PAS QUAND CHAUD. NICHT BEI HEISSEM MOTOR ÖFFNEN. 熱い時あけないでください。高温時、请勿打开

Warning Labels (continued)

⚠ DANGER	⚠ PELIGRO	⚠ DANGER
<p>IMPACT Strong impact (i.e., dropping the battery, collision damage) may cause electrolyte leaks, internal short circuits and heat increase resulting in fire. Avoid impact to the battery.</p> <p>FLAMMABLE LIQUID and VAPOR Battery damage may cause flammable gas or electrolyte leaks and may result in fire. Do not damage the battery and keep sparks, flame and cigarettes away.</p> <p>CHEMICAL HAZARD - CORROSIVE Organic electrolyte may cause severe burns to skin and eyes. Wear personal protective equipment.</p> <p>POISON Organic electrolyte is poisonous. If ingested, get medical attention immediately.</p> <p>KEEP OUT OF REACH OF CHILDREN</p>	<p>IMPACTO Impacto fuerte (es decir, dejar caer la batería, el daño causado por la colisión) puede causar fuga de electrolitos, cortocircuitos internos y aumento de temperatura pudiendo provocar un incendio. Evite el impacto a la batería.</p> <p>LÍQUIDOS INFLAMABLES y VAPOR Daño en la batería puede causar fuga de electrolitos o gas inflamable y puede provocar un incendio. No dañe la batería y manténgase lejos de chispas, fuego y cigarrillos.</p> <p>RIESGO QUÍMICO - CORROSIVO El electrolito orgánico puede causar severas quemaduras en la piel y los ojos. Use equipo de protección personal.</p> <p>VENENO El electrolito orgánico es venenoso. En caso de ingestión, busque atención médica inmediatamente.</p> <p>MANTÉNGASE FUERA DEL ALCANCE DE LOS NIÑOS</p>	<p>CHOC Choc important (c'est à dire : faire tomber la batterie, les dommages par collision) peut provoquer des fuites d'électrolyte, courts-circuits internes et l'élevation de la température qui peuvent entraîner un incendie. Éviter tout choc sur la batterie.</p> <p>LIQUIDE et VAPEUR INFLAMMABLES L'endommagement de la batterie peut provoquer des fuites de gaz ou d'électrolyte inflammables et peut entraîner un incendie. Ne pas endommager la batterie. Éloigner de toute étincelle, flamme nue ou cigarette allumée.</p> <p>RISQUE CHIMIQUE - CORROSIF L'électrolyte organique peut causer de graves brûlures à la peau et aux yeux. Porter un équipement de protection individuelle.</p> <p>POISON L'électrolyte organique est toxique. En cas d'ingestion, consulter immédiatement un médecin.</p> <p>GARDER HORS DE LA PORTÉE DES ENFANTS</p>
 SHIELD EYES PROTEJA LOS OJOS PROTÉGEZ LES YEUX	 NO FIRE NO INCENDIO ÉVITER INCENDIE	 GET MEDICAL HELP FAST OBTENGA AYUDA MEDICA RAPIDA OBTENIR RAPIDEMENT AIDE MEDICALE
 Li-ion		

⚠ WARNING

HIGH VOLTAGE

- You can be killed or hurt.
- Do not remove this cover.
- No customer serviced parts inside.

A0

⚠ WARNING

HIGH VOLTAGE

You can be killed or hurt.
Do not disconnect, open, or take apart.

A0

<p>LITHIUM-ION BATTERY DISPOSAL INFORMATION</p> <p>This 259V high voltage battery requires special handling and disposal process. Contact for instructions, in USA : American Honda 1-800-555-3497 in Canada : Honda Canada 1-800-946-6329</p>	<p>MISE AU REBUT DES BATTERIES LITHIUM-ION</p> <p>La manutention et la mise au rebut de la batterie haute tension de 259V nécessitent un processus spécial. Veuillez contacter pour le processus, dans USA : American Honda au 1-800-555-3497 dans Canada: Honda Canada au 1-800-946-6329</p>
---	--

⚠ DANGER	⚠ PELIGRO	⚠ DANGER
<p> HIGH VOLTAGE You will be killed or hurt. Before servicing</p> <ul style="list-style-type: none"> ■ Switch vehicle power mode to off and remove high-voltage battery service plug. ■ Wear insulated gloves and use insulated tools. ■ Check voltage at high-voltage battery box terminals. ■ Follow all service manual instructions. 	<p> ALTA TENSION Peligro de accidente o muerte. Antes de manipular</p> <ul style="list-style-type: none"> ■ Cambie el interruptor de encendido del vehículo a OFF y retire el conector de servicio de la batería de alta tensión. ■ Utilice guantes y herramientas aislantes. ■ Compruebe el voltaje en las terminales de la caja de la batería de alta tensión. ■ Siga todas las instrucciones del manual de servicio. 	<p> HAUTE TENSION Danger de mort ou de blessures. Avant le service</p> <ul style="list-style-type: none"> ■ Mettre le mode d'alimentation du véhicule à OFF, puis retirer le capuchon de la prise de service de la batterie haute tension. ■ Porter des gants isolants et utiliser des outils isolés. ■ Vérifier la tension aux bornes du boîtier de la batterie haute tension. ■ Suivez toutes les instructions du manuel d'atelier.

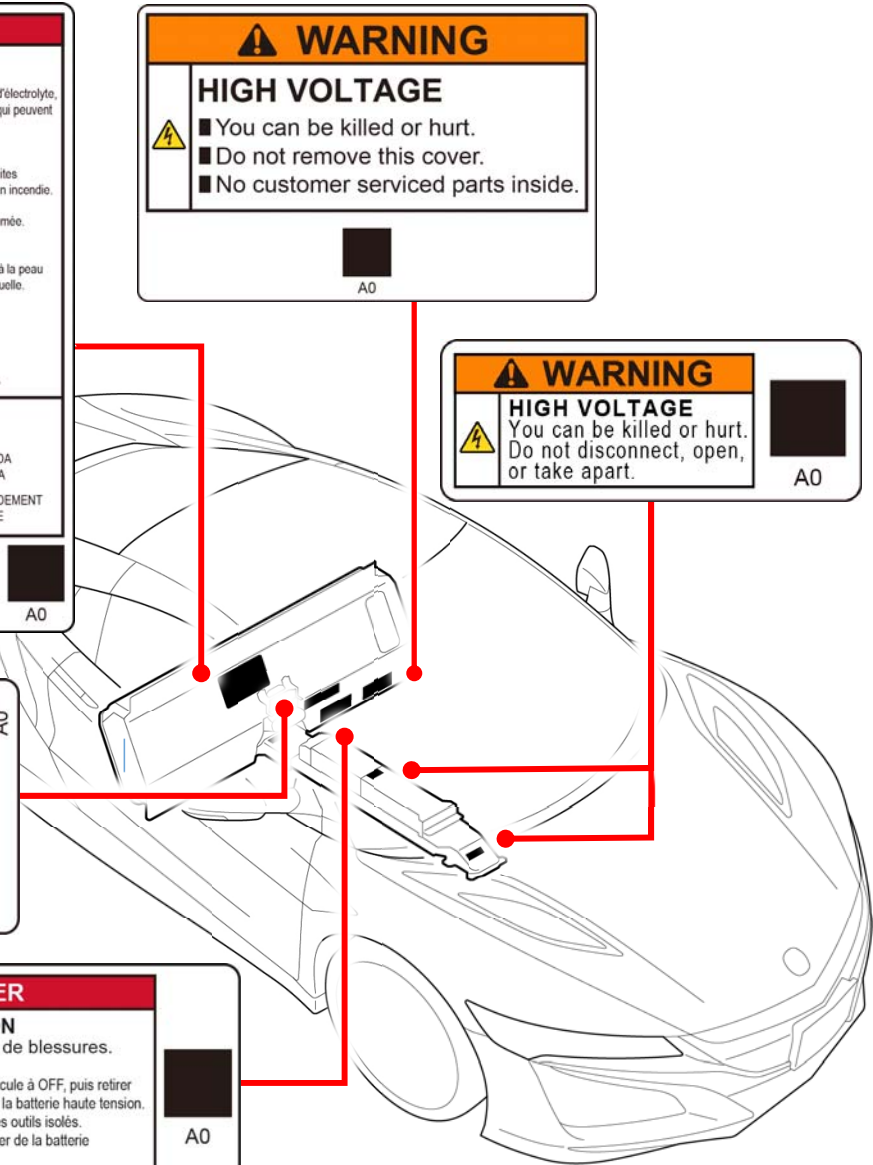

High-Voltage Components and Locations

Electric Motor/Generator

The Acura NSX incorporates one of three electric motor/generators attached to the gasoline engine.

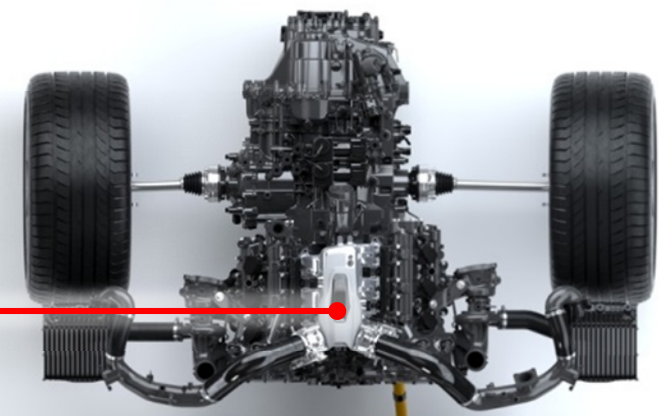

High-Voltage Battery

The high-voltage battery is located in a well-protected area behind the seats.

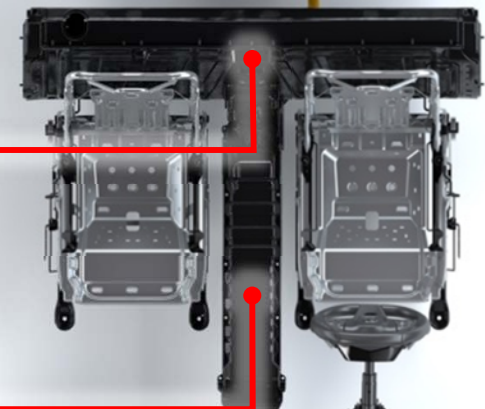
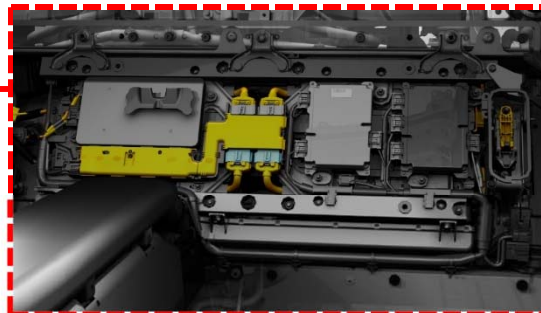

Power Drive Unit (PDU)

The PDU is located below the center console and houses the liquid-cooled inverter. There are no serviceable parts inside, so there is no reason for it to be opened or disassembled.

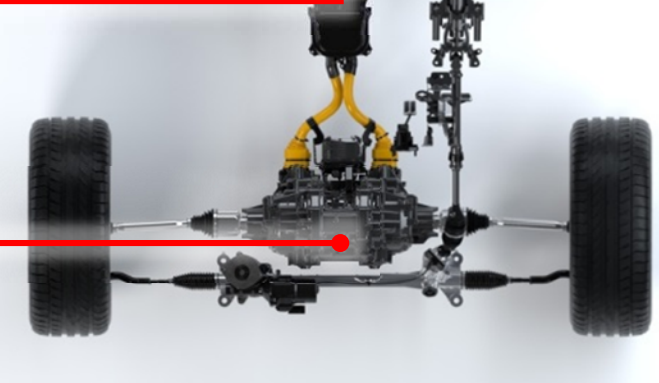
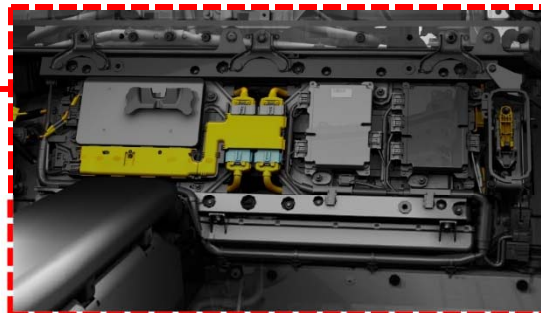

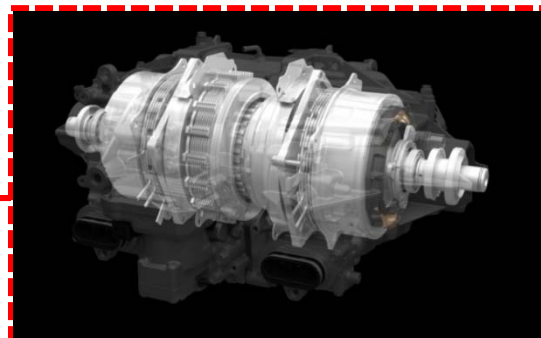

Twin Motor Unit

Two electric motors are located between the front wheels in the twin motor unit.



How to Determine if Vehicle is in ON / OFF Mode.

Check the POWER button and the gauges for the vehicle status.

<p>Vehicle is OFF</p> <p>The power to all electrical components is turned off.</p> <ul style="list-style-type: none"> • The POWER button and the green indicator are OFF. • Pressing the POWER button once will change to the Accessory mode. 	 <p style="text-align: center;">OFF</p>
<p>Vehicle is in Accessory</p> <p>You can operate the audio system and other accessories in this position.</p> <ul style="list-style-type: none"> • The POWER button is blinking and the green indicator is ON. • Press the POWER button twice to turn off the vehicle. • Pressing the POWER button once will change to the ON mode. 	 <p style="text-align: center;">BLINK</p>
<p>Vehicle is ON</p> <p>The Engine is OFF but all electrical components can be used.</p> <ul style="list-style-type: none"> • The POWER button and the green indicator are ON. • Press the POWER button once to turn off the vehicle. • While pressing the brake pedal, pressing the POWER button once will turn on the READY indicator and Ready To Drive will be shown in the Multi-Information Display (MID). 	 <p style="text-align: center;">BLINK</p>

Vehicle is Ready to Drive

The **READY** indicator is ON and **Ready To Drive** is shown on the MID.

- The POWER button is ON.
- Depending on the high-voltage battery state of charge, the **EV** indicator or the Engine may be ON.
- Press the POWER button once to turn off the vehicle.



ON





Parking the Vehicle

NOTE:

- The following features will only operate if the vehicle's 12-volt battery power is available.
- If the 12-volt power IS NOT available, use available wheel chocks.

1. Press the POWER button twice to turn the vehicle ON.
2. Press the P on the Electronic Gear Selector to shift the transmission to Park, or N to shift the transmission to Neutral.



3. Push the POWER button to turn the vehicle OFF.
4. If necessary, pull up the Electric Parking Brake switch to apply the parking brake.



Applying the Electric Parking Brake
The electric parking brake can be applied any time the vehicle has 12-volt battery power no matter what state the power mode is in.

Pull up the Electric Parking Brake switch gently and securely.

The parking brake and Brake System indicator come on.



Releasing the Electric Parking Brake
The power mode must be turned to ON to release the electric parking brake.

1. Press the and hold the brake pedal.
2. Press the Electric Parking Brake switch.

The parking brake and Brake System indicator go off.

Lifting the Vehicle

Use the indicated lifting points to raise the vehicle.

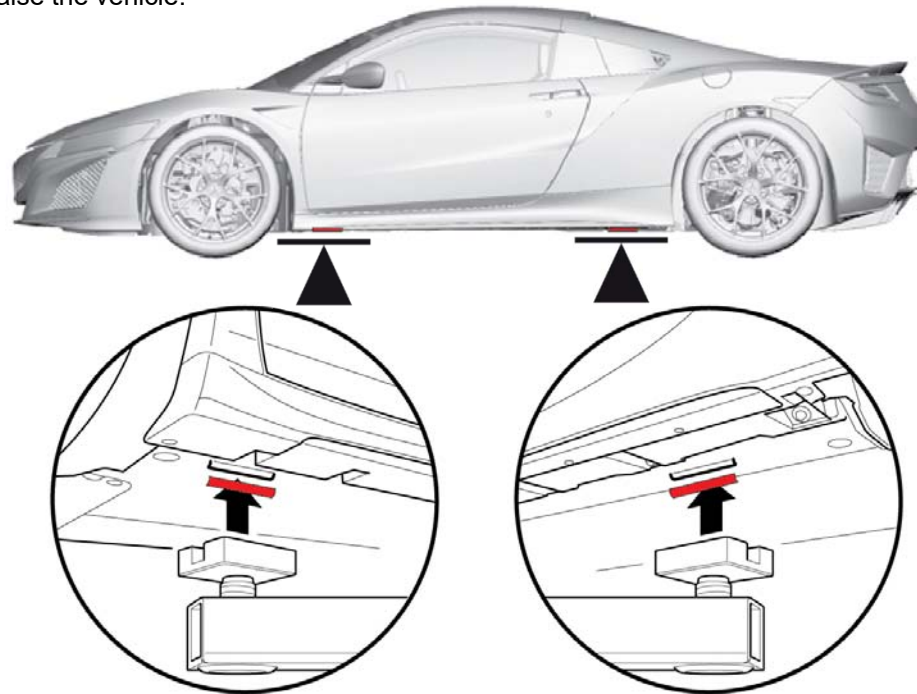

Some models have jacking brackets on both sides of the vehicle. Use a floor jack with a rubber pad or rubber attachment to avoid damaging the vehicle.

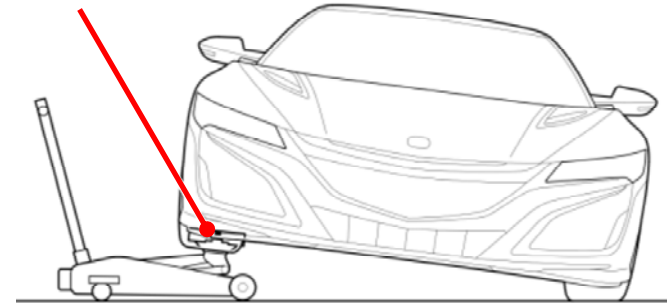
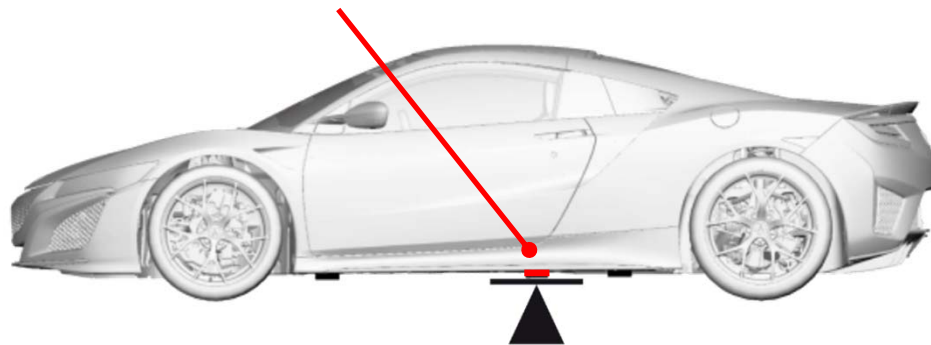

Preventing Current Flow Through High-Voltage Cables

Before attempting to rescue occupants or move a damaged Acura NSX, you should reduce the potential for current to flow from the electric motor or the high-voltage battery through the high-voltage cables.

There are **two recommended methods** for preventing current flow. These are discussed in the following pages.

PREFERRED METHOD for High-Voltage Shutdown

Push and hold the POWER button for 3 seconds.

This simple action turns off the vehicle and immediately shuts down the high-voltage system controllers, thereby preventing current flow into the cables. It also cuts power to the airbags and the front seat belt tensioners, though these pyrotechnic devices have up to a **3-minute** deactivation time.

To prevent accidental restarting, you must remove the keyless remote from the vehicle and move it at least **20 feet** away.

If you cannot locate the keyless remote, disconnect the negative terminal from the 12-volt battery to prevent electrical fires and accidental restarting of the vehicle.



20 FEET



OFF



ON



Push and Hold = 3 Sec.

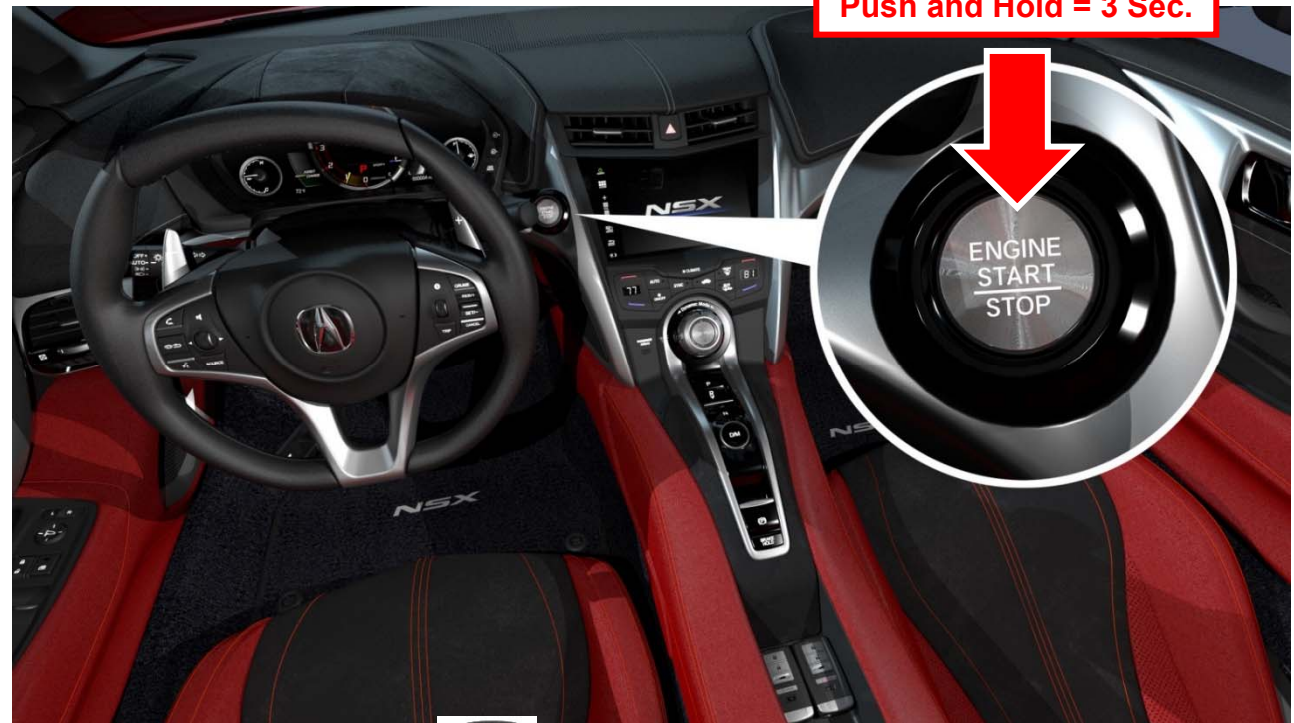

HIGH-VOLTAGE SHUTDOWN PROCEDURE (PREFERRED)

ALTERNATIVE BEST METHOD for High-Voltage Shutdown

Locate and cut the negative 12-volt battery cable and the DC to DC converter cable under the hood.

Together, cutting the negative 12-volt battery cable and the DC to DC converter cable immediately turns off and shuts down the high-voltage system controllers and the engine, thereby preventing current flow into the high-voltage cables.

1. Pull the hood release handle under the driver's side lower corner of the dashboard. The hood will pop up slightly.



2. Push the hood latch lever (located under the front edge of the hood to the center) to the side, and raise the hood.



Continued on the next page



ALTERNATIVE BEST METHOD for High-Voltage Shutdown (continued)

3. Locate the two cut point labels as shown, and cut them.

If touching high-voltage cables and other high-voltage components is unavoidable, personal protective equipment (insulating gloves, goggles, and boots) should always be worn.

This also cuts power to the airbags and the front seat belt tensioners, but remember these pyrotechnic devices have up to a **3-minute** deactivation time.

NOTE: When cutting the cables, do not allow the cutting tool to contact any surrounding metal parts; electrical arcing could occur, igniting any flammable vapors.

If you cannot do either method to stop the engine and prevent current flow into the high-voltage cables, use extreme care and do not touch damaged cables as they may be electrically charged.

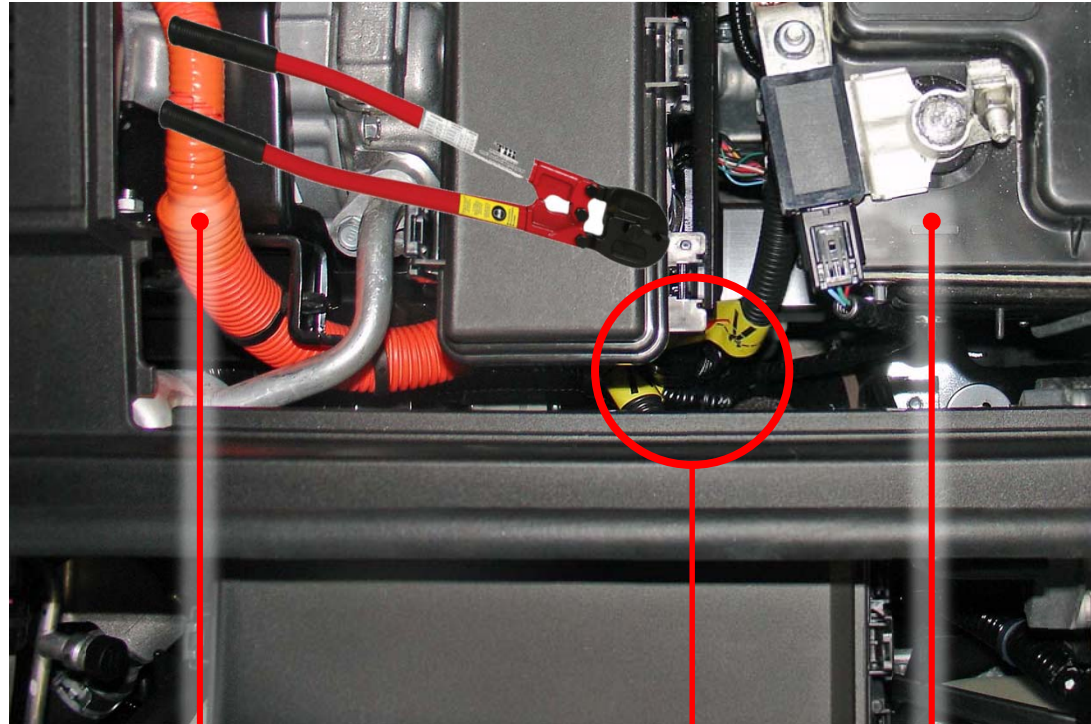

High-Voltage Cables

12-Volt Battery



HIGH-VOLTAGE SHUTDOWN PROCEDURE (ALTERNATIVE)

High-Strength and Ultra-High-Strength Steel

The body of the Acura NSX is made of high-strength steel and ultra-high-strength steel indicated in the colored areas.

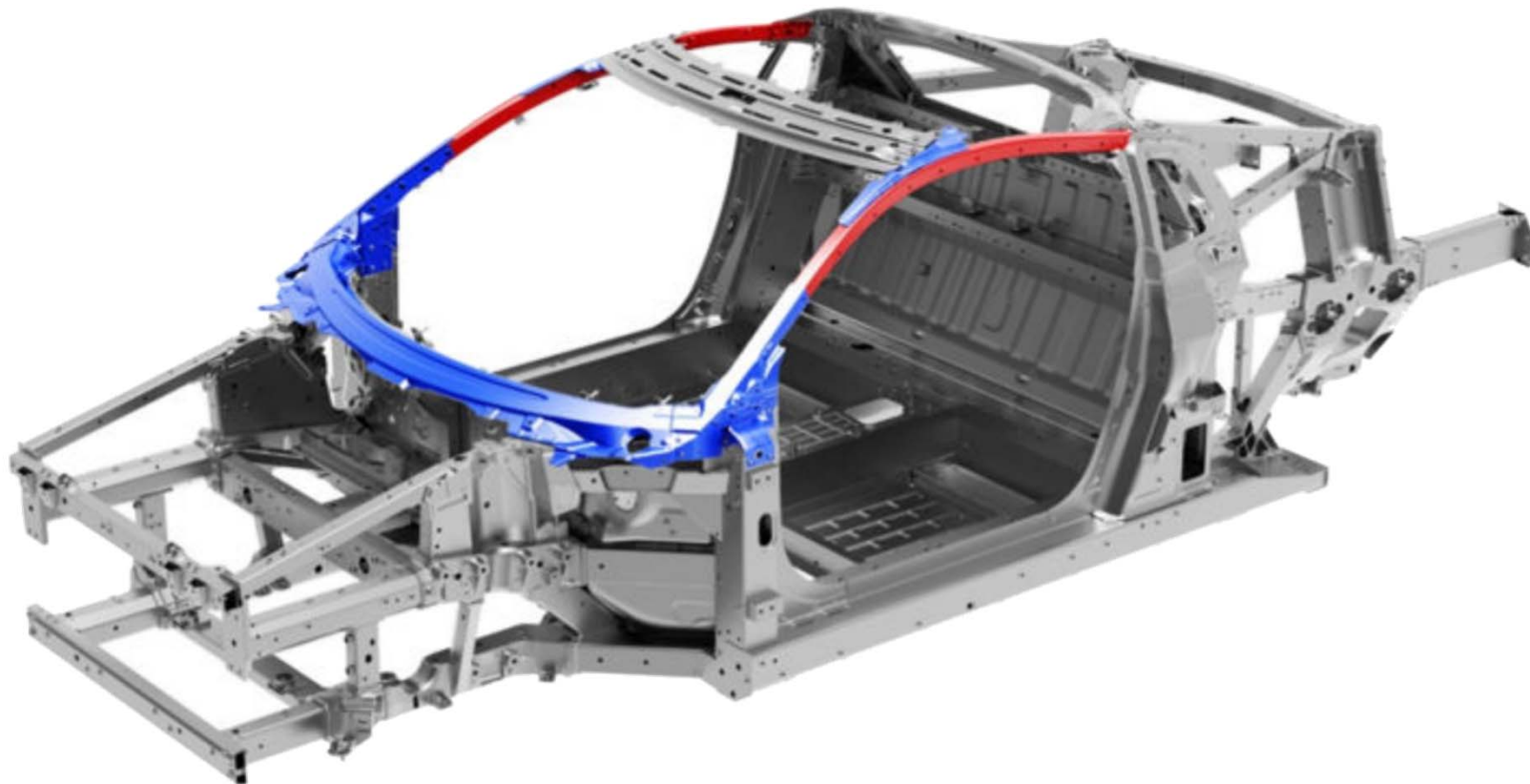

Ultra High-Strength Steel (UHSS)

1500
Mpa

High-Strength Steel (HSS)

590
Mpa

Extricating Occupants

If you need to cut the vehicle body or use Jaws-of-Life equipment to remove occupants, be sure to stay within the cut zone as shown.

When cutting the vehicle body, personal protective equipment (insulating gloves, goggles, and boots) should always be worn.

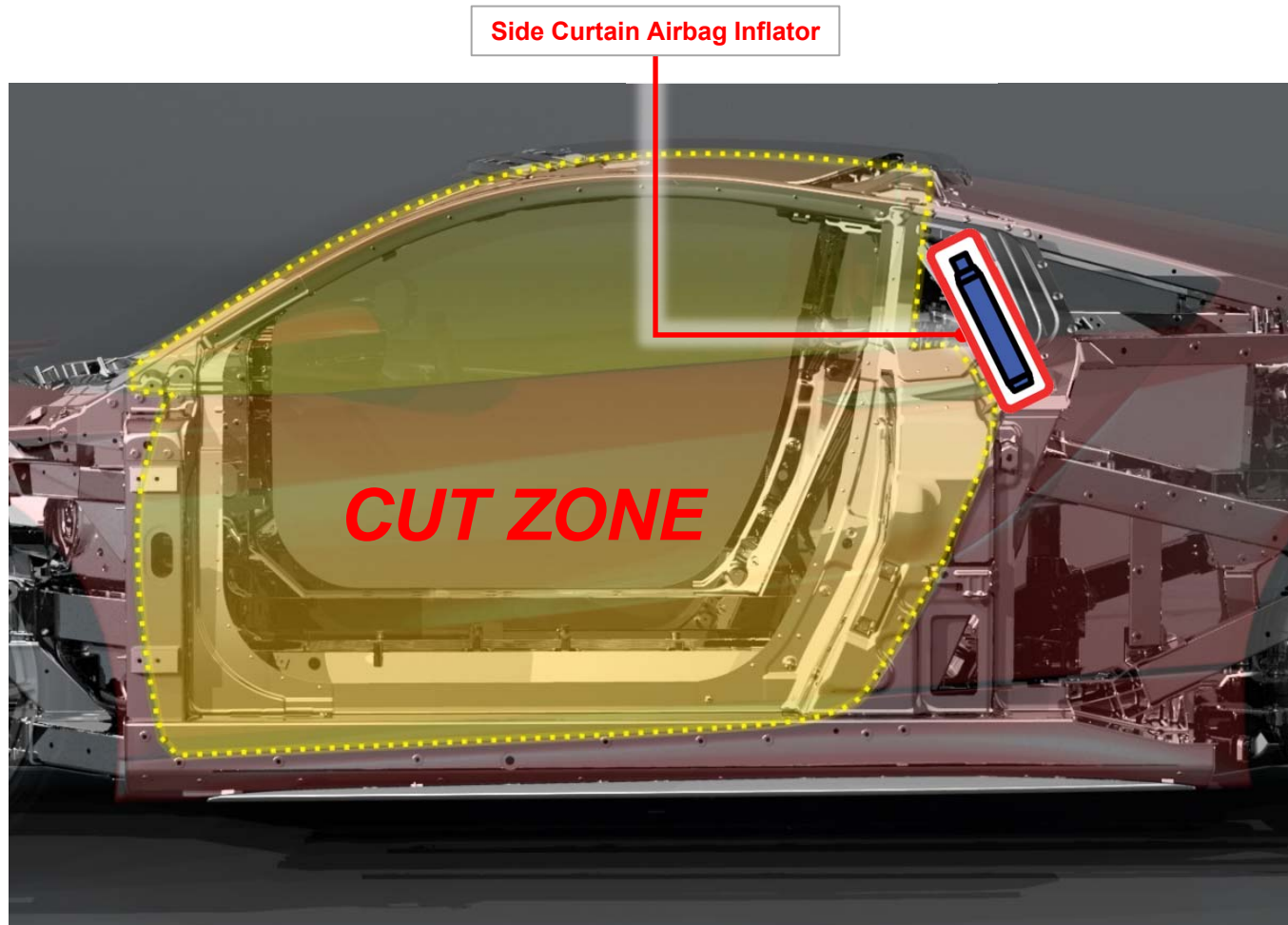

Extricating Occupants

Under normal operation, the outer door handle automatically pops out when you are carrying the remote and get near the door. The outer door handle also pops out when the unlock button is pressed on the remote.



In the event of an emergency, simply push in the front edge of the outer door handle so that the handle pops out, then pull the outer handle toward you and open the door. The door will open as long as the door is unlocked.

Moving the Seats and Steering Wheel

Driver's Power Seat











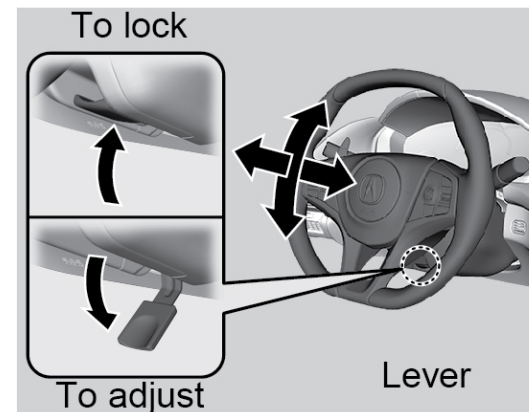

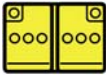

Passenger Manual Seat







To adjust the steering wheel position:

1. Pull the steering wheel adjustment lever up. The steering wheel adjustment lever is under the steering column.
2. Move the steering wheel up or down, and in or out.
3. Push the steering wheel adjustment lever down to lock the steering wheel in position.



Type	Capacity	Content	Dangers
12-Volt Battery 	12 V—60 Ah/20 HR (12 V—48 Ah/5 HR)	<ul style="list-style-type: none"> • Lead 60% • Lead peroxide 25% • Sulfuric acid 14% • Lead sulfate 1% 	 
Lithium-Ion, High-Voltage Battery 	259.2 V 72 (3.6 V) (18 cells × 4 modules)	<ul style="list-style-type: none"> • Lithium metal oxide 10-20% • Carbonic acid esters 10-20% • Carbon 5-15% • Lithium salt 1-5% • Polyvinylidene flouride 0.5-3% 	 
Engine Oil	10.4 US qt (9.8 L)	<ul style="list-style-type: none"> • Distillates, petroleum, hydrotreated heavy paraffinic. 	  
Gasoline Tank 	15.6 US gal (59 L)	<ul style="list-style-type: none"> • Gasoline 88-100% • Ethanol less than 10% • Toluene less than 10% • 1,2,4-Trimethylbenzene less than 5% • Benzene less than 5% • N-Hexane less than 3% 	 
Engine Coolant	5.39 US gal (20.4 L)	<ul style="list-style-type: none"> • Water 45-55% • Ethylene glycol 43-49 % • Hydrated inorganic acid, organic acid salts less than 5% • Diethylene glycol less than 3% 	
High-Voltage Battery Coolant	0.634 US gal (2.4 L)		

Type	Capacity	Content	Dangers
Front Differential Fluid (Twin Motor Unit)	3.6 US qt (3.4 L)	<ul style="list-style-type: none"> • Lubricating base stocks 80-90% • N-Phenyl-1-naphthylamine less than 1% 	
Dual Clutch Transmission Fluid (Clutch Side)	4.8 US qt (4.5 L)		
Transmission Fluid	7.9 US qt (7.5 L)	<ul style="list-style-type: none"> • Base oil 80-90% • Additives less than 20% • Mineral oil 2-4% 	Not provided on SDS
Brake Fluid	N/A	<ul style="list-style-type: none"> • Mixture of glycol ether, glycol derivative, glycol ether borate ester (except diethylene glycol) 89-99 % • Diethylene glycol less than 10% 	Not provided on SDS
Air Conditioning Refrigerant 	2017-19 16.05 – 17.81 oz (455 – 505 g)	2017-19: <ul style="list-style-type: none"> • Tetrafluoroethane (R-134a) 100% 	
	2020-22 14.29 – 16.05 oz (405 – 455 g)	2020-22: <ul style="list-style-type: none"> • Tetrafluoroprop-1-ene (R-1234yf) 100% 	
Windshield Washer Fluid	2.6 US qt (2.5 L)	<p>Concentrate:</p> <ul style="list-style-type: none"> • Methyl alcohol (methanol) more than 99% <p>Tablet:</p> <ul style="list-style-type: none"> • Sodium carbonate (2:1) 40 to 55% • Citric acid 20 to 40% • Ethoxylated fatty alcohols 0.1 to 3% • Alkoxyated alcohols 0.1 to 2% 	

Fire Extinguishing Methods

In case of vehicle high-voltage battery fire, the fire should be extinguished using the following procedure where possible.

If touching high-voltage cables and other high-voltage components is unavoidable, personal protective equipment (insulating gloves, goggles, and boots) should always be worn.

1. Extinguish the fire using a large volume of water such as from a fire hydrant, well water, or pond water. If water is not available, an ABC powder fire extinguisher may be used as an alternative
2. If it is safe to do so, open the driver's and passenger's side doors and direct water to the rear bulkhead upper trim behind the headrests
3. Continue extinguishing until a complete suppression of fire and smoke is observed from the battery.
4. Once signs of active fire have completely subsided (e.g. no visible smoking), a thermal camera should be used to evaluate and monitor the temperature of the battery unit.

NOTE: The battery temperature should continue to be monitored. If the battery temperature begins to increase, a possibility for reignition exists and additional water or a fire extinguisher should be used to mitigate reignition.

WARNING:

- Do NOT attempt to open the battery cover at this time.
- Never use seawater or any water containing salt.
- Always assume the high voltage battery contains stranded energy and a possibility for reignition exists.

See Section 8 (Towing/Transportation/Storage) for additional procedures including discharging the high voltage battery.



Submerged Vehicle

If an Acura NSX is submerged or partly submerged in water, first pull the vehicle out of the water, then shut down the high-voltage system.

See Section 3 (Disable Direct Hazards / Safety Regulations) for the high-voltage shutdown procedures.

If touching high-voltage cables and other high-voltage components is unavoidable, personal protective equipment (insulating gloves, goggles, and boots) should always be worn.

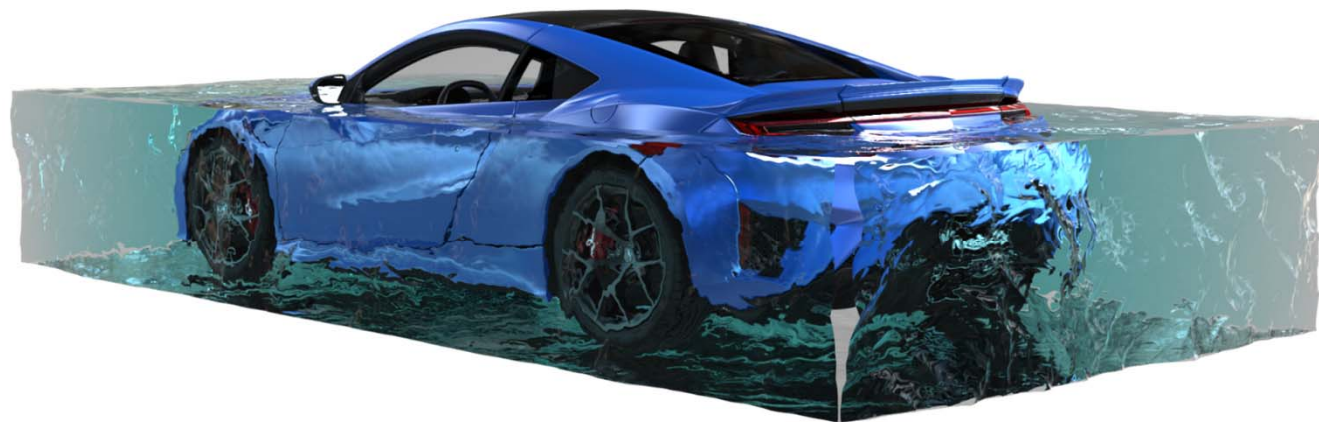

Aside from severe damage to the vehicle, there is no risk of an electric shock from touching the vehicle's body or framework - in or out of the water. If the high-voltage battery was submerged, you may hear noises from the battery as the cells are being discharged from shorting.

See Section 8 (Towing/Transportation/Storage) for additional procedures including discharging the high voltage battery.

Shifting the Vehicle into Neutral

NOTE:

- The following features will only operate if the vehicle's 12-volt battery power is available.
- If the 12-volt power IS NOT available, use available wheel chocks or dollies.
- See Section 2 (Immobilization/Stabilization/Lifting) for additional procedures including parking the vehicle.

1. Press the POWER button to turn the vehicle ON.
2. Press and hold the brake pedal.
3. Press the N on the Electronic Gear Selector to shift the transmission to Neutral. The message, Neutral Hold will appear on the gauge.

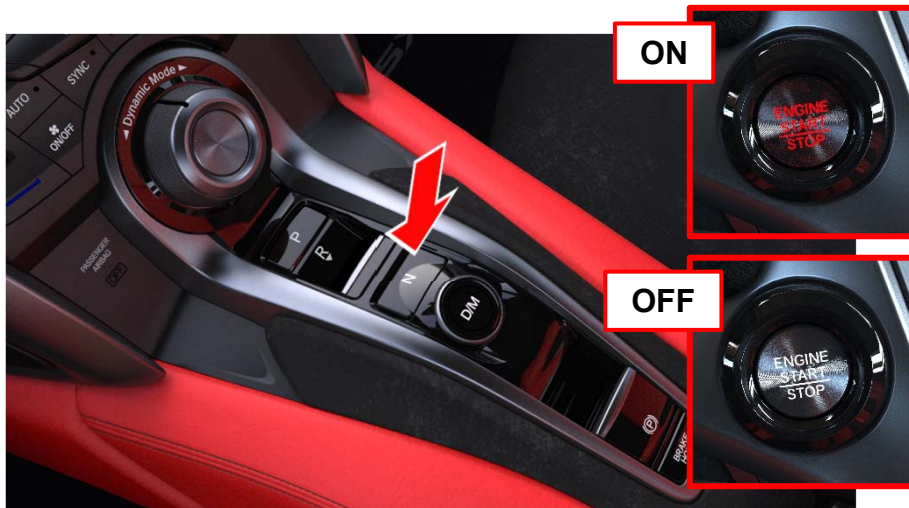

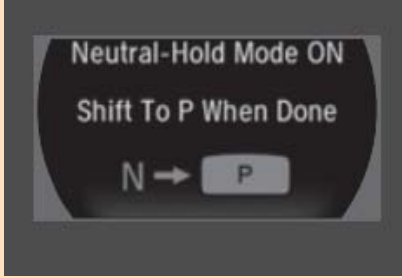

- For **15 minutes**, the transmission remains in neutral and the power mode will remain in ACCESSORY. After that, the transmission automatically shifts to park.

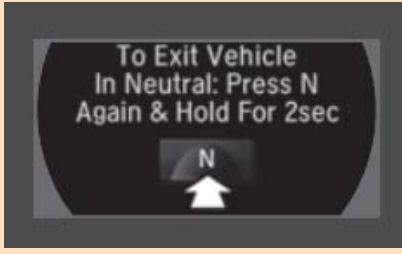

- If the POWER button is pressed after the neutral hold has been activated, the power mode will switch to ACCESSORY and a message will be displayed on the gauge.



4. Press N again, and hold it for **2 seconds**. The vehicle will enter neutral hold mode.
5. If necessary, press the Electronic Parking Brake button to release the parking brake.
6. Release the brake pedal and push the POWER button to turn the vehicle to ACCESSORY.

NOTE: Manually shifting to park cancels ACCESSORY mode. The P indicator comes on, and the power mode changes to OFF. Always shift the transmission to park when neutral hold is no longer necessary.

Emergency Towing

The only method for emergency towing is to use a flat-bed tow truck. **DO NOT** use cable type or front wheel type lift equipment.

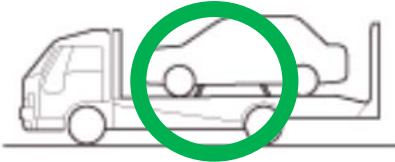
NOTE: If there is a 12-volt power failure, the vehicle cannot be shifted into neutral. Use available wheel dollies.

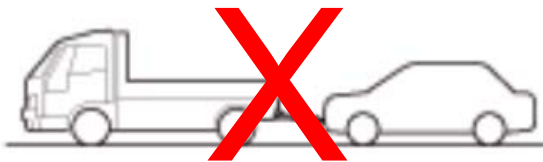
Flat-Bed	Front Wheel Type	Cable-type
		
<ol style="list-style-type: none"> 1. Secure the vehicle on the flat-bed tow truck. 2. Apply the parking brake. 	<p style="text-align: center;">Never tow this vehicle with front wheel type equipment.</p>	<p style="text-align: center;">Never tow this vehicle with cable-type equipment.</p>

Be aware that when rolling an Acura NSX with the front and/or rear wheels on the ground, the electric motor can produce electricity and remains a potential source of electric shock even when the high-voltage system is turned off.

Carry a fire extinguisher during transportation and for enhanced safety, have the flat-bed tow truck with the damaged vehicle followed by another support vehicle for monitoring. After transportation, discharge the battery if necessary. See Battery Discharging in this section.

⚠ WARNING

If the orange high-voltage cables or high-voltage covers have been damaged, exposing wiring, terminals, or other components, the exposed parts should never be touched. Doing so could result in serious injury or death due to severe burns or electric shock.

If it is not clear whether the exposed wires and terminals are high-voltage components or not, do not touch them.

If touching high-voltage cables and other high-voltage components is unavoidable, personal insulating protective equipment (insulating gloves, protective goggles, and insulating boots) should always be worn.

Acoustic Vehicle Alerting System

Starting with the 2020 model year, the Acura NSX is equipped with an acoustic vehicle alerting system that alerts pedestrians with an audible sound that it is approaching at low speeds or when stationary and in a gear position that would allow the vehicle to move. When pushing the Acura NSX with the ignition turned to ON, you will hear this sound as the vehicle is being moved.



Emergency Towing (continued)

The Acura NSX can only be towed using the detachable front tow hook. The detachable front tow hook can be found in the tool box in the trunk.



NOTE:

- Do not use the front tow hook as a tie down for securing the vehicle on a flat-bed tow truck.
- This vehicle is not equipped with a rear towing hook. Do not use the rear bumper as a towing hook. It will cause severe damage to the rear of the vehicle.



Lifting the Vehicle

Use the indicated lifting points to raise the vehicle.

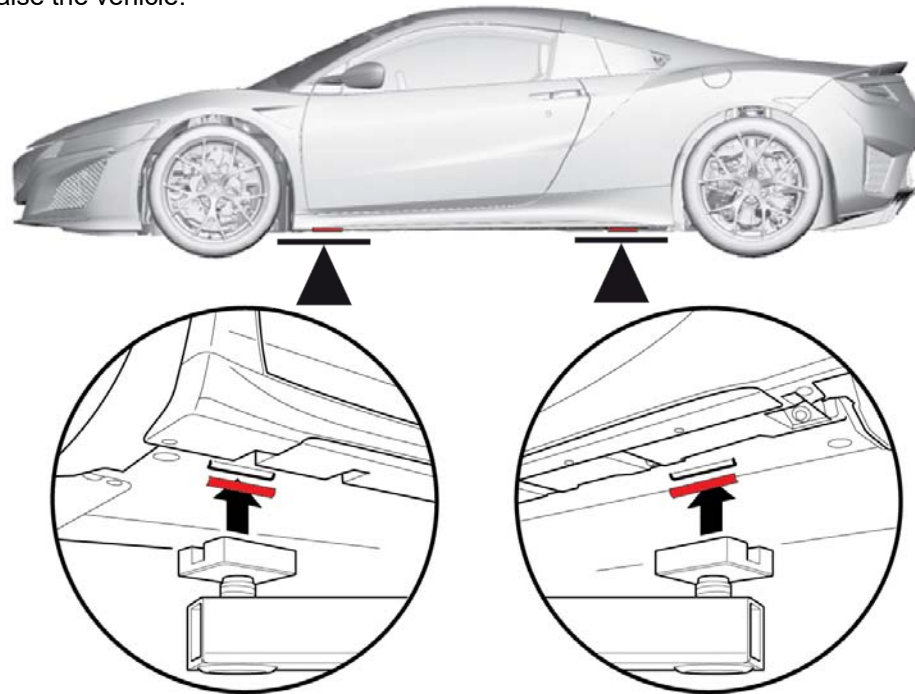

Some models have jacking brackets on both sides of the vehicle. Use a floor jack with a rubber pad or rubber attachment to avoid damaging the vehicle.

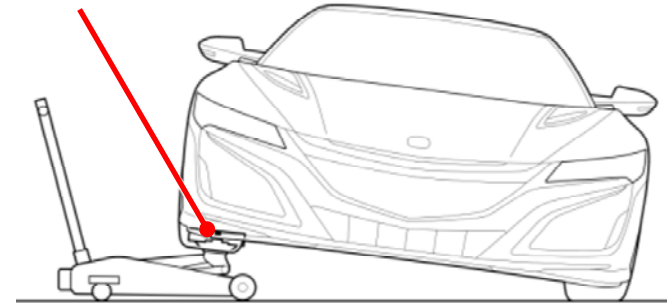
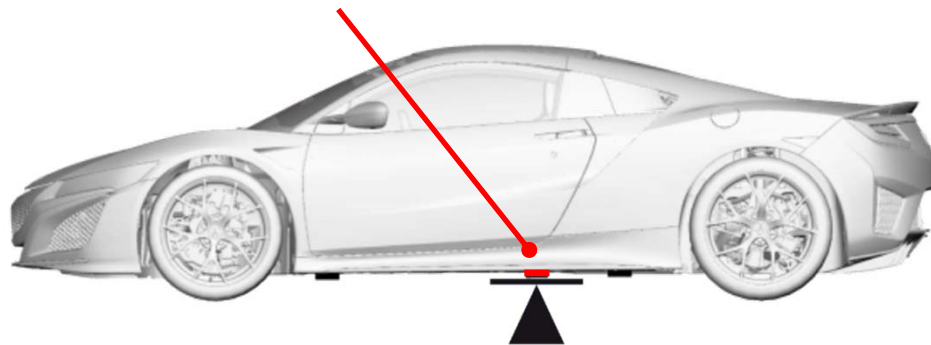

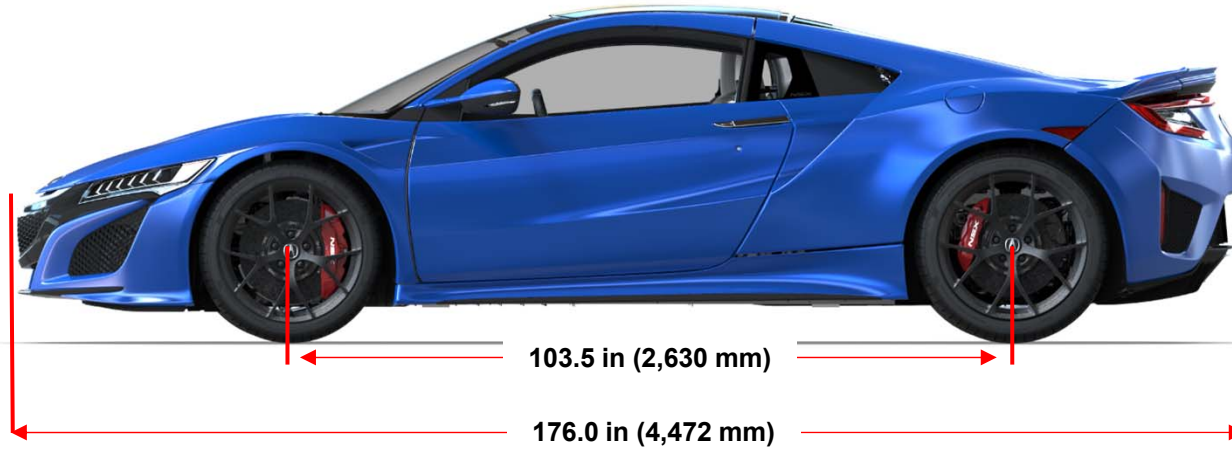

Gross Vehicle Weight Rating	
USA Models	3,803 lbs (1,725 kg) ~ 3,966 lbs (1,799 kg)
Central America Models	1,763 kg ~ 1,804 kg

Storing the Vehicle

The damaged vehicle can be stored in either Open Perimeter Isolation or Barrier Isolation.

Open Perimeter Isolation

Store the vehicle in an outdoor area separated from all combustibles and structures by a minimum distance of **50 feet (15.2 m)** from all sides.



Barrier Isolation

- Store the vehicle in an outdoor area separated from all combustibles and structures with a barrier constructed of earth, steel, concrete or solid masonry designed to contain a fire or prevent the fire from extending to adjacent vehicles.
- The barriers should be of sufficient height to direct any flame or heat away from adjacent vehicles.
- If the barrier is only on three of the four sides of the vehicle, the open side must maintain the separation distance referenced above.
- It is not recommended to fully enclose the vehicle in a structure due to the risk of post-incident fire extending to the structure and the possibility of trapped explosive or harmful gases. Therefore, a roof is not recommended for barrier isolation.

Battery Discharging

If the high-voltage battery is severely damaged **or burned**, or the vehicle has been submerged, and **water has entered and accumulated on the floor of passenger compartment**, the battery must be discharged. Failure to discharge stored or stranded energy remaining in the battery may result in a fire or re-ignition due to a damaged or short circuit.

See Section 3 (Disable Direct Hazards / Safety Regulations) for procedures including disconnecting the 12-volt battery.

If touching high-voltage cables and other high-voltage components is unavoidable, personal protective equipment (insulating gloves, goggles, and boots) should always be worn.

1. Open the driver's door.
2. Use the power seat controls to slide the driver's seat position and the seatback angle all the way forward.



3. Disconnect the 12-volt battery.

Continued on the next page.

Battery Discharging (continued)

- Remove the driver's side rear side trim panel.

Fastener Locations

A ▷ : 2 B ▷ : 1

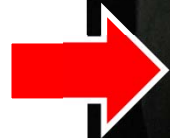
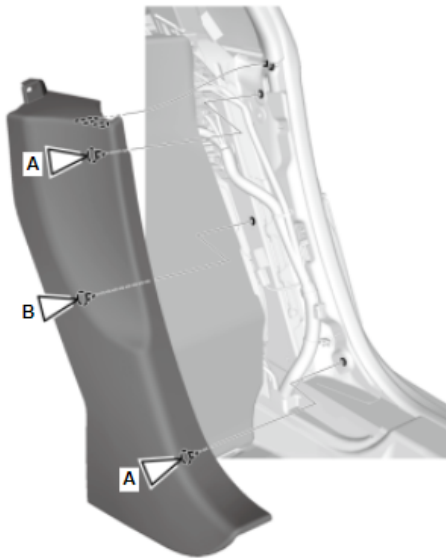
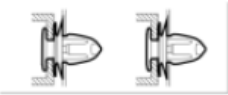

- Pull the rear bulkhead carpet back as needed.
- Remove the service plug cover 10 mm bolts, then remove the service plug cover.

Continued on the next page.



Battery Discharging (continued)

7. While pushing down the tab, raise the lever to remove the service plug.

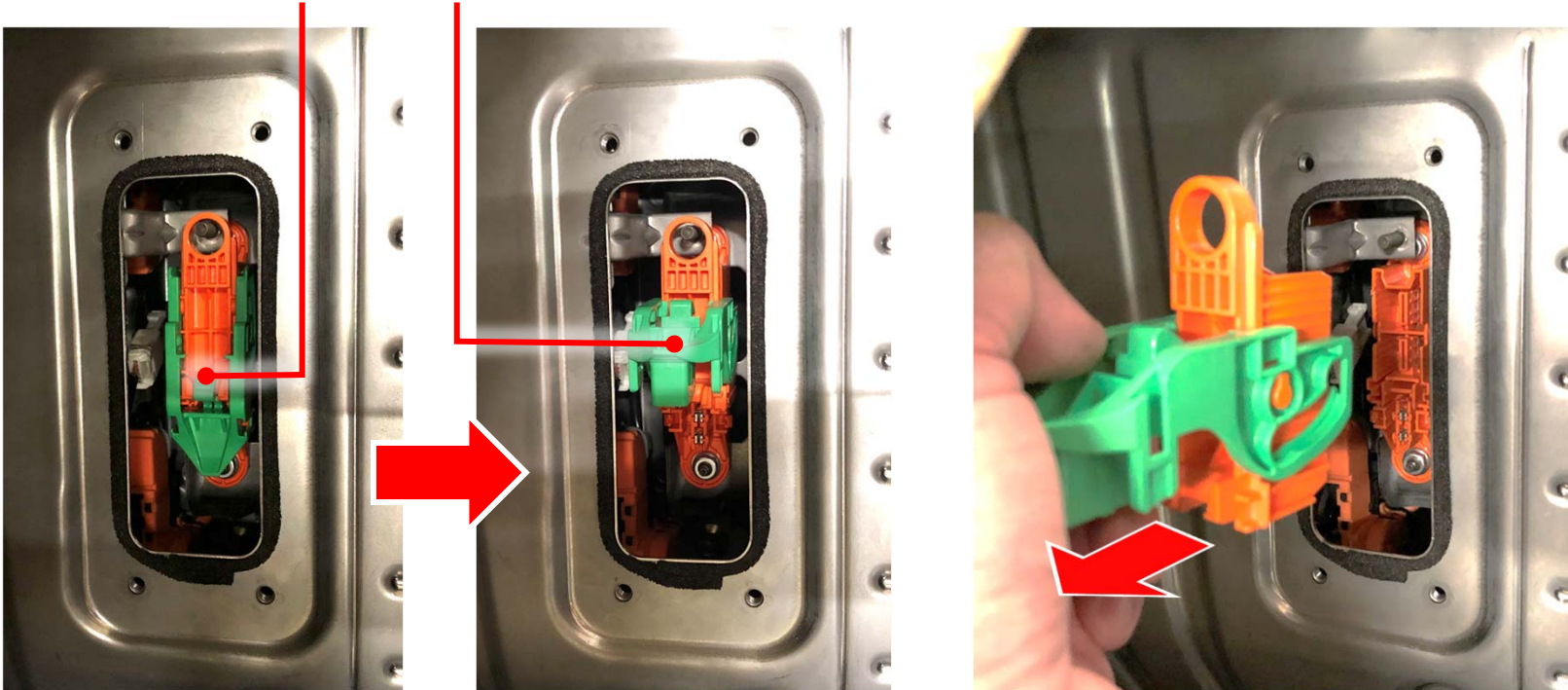

8. Set up a pool approximately **16.5 feet long x 9 feet wide x 3 feet high** in a well-ventilated outdoor area.
9. Use a forklift or similar equipment to place the vehicle in the center of the pool.

Continued on the next page.



Battery Discharging (continued)

- Fill the easy set pool with water from a fire hydrant, well water, or pond water until the high voltage battery is completely submerged. If there is a risk of water leakage from the easy set pool, place a thick plastic sheet under the pool.

Never use seawater or any water containing salt.



- Continue filling the easy set pool to a minimum depth of **2.6 feet (793 mm)** until the high voltage battery is completely submerged.

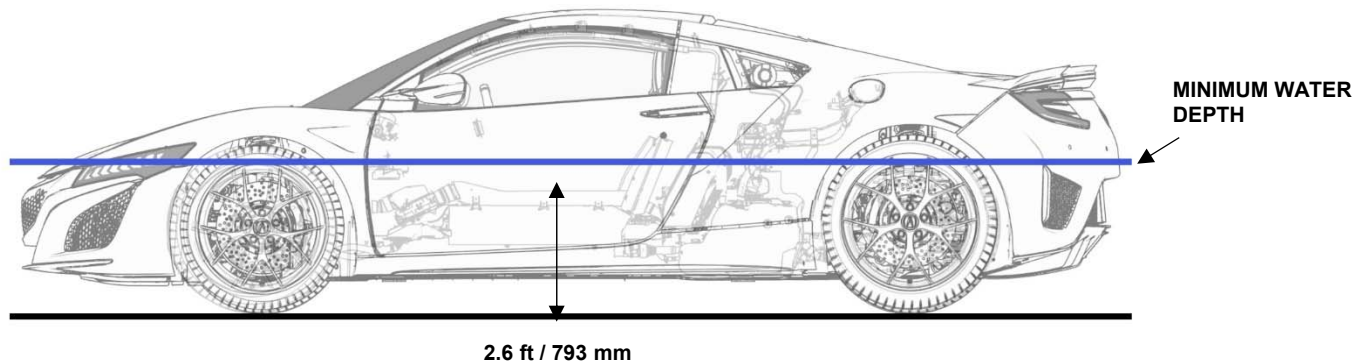

- Maintain this water level for at least **3.5 days**. If the water level drops below the minimum specified level, add fresh water.

Since the water used for discharging the battery is converted to an aqueous solution containing metals such as Phosphorus (P) and Lithium (Li), dispose of it properly as an industrial waste according to local regulations.



Lithium-Ion Battery Fumes or Fire

A damaged high-voltage lithium-ion battery can emit toxic fumes, and the organic solvent used as electrolyte is flammable and corrosive. Responders should wear appropriate personal protective equipment. Even after a lithium-ion battery fire appears to have been extinguished, a renewed or delayed fire can occur. The battery manufacturer cautions responders that extinguishing a lithium-ion battery fire will take a large and sustained volume of water.

In order to minimize the possibility of collateral fire damage, responders should always ensure that an Acura NSX with a damaged battery is kept outdoors and far away from other flammable objects.



Lithium-Ion Battery Fluid

Avoid contact with the high-voltage battery fluid. The high-voltage battery contains a flammable electrolyte that could leak as a result of a severe crash. Avoid any skin or eye contact with the electrolyte as it is corrosive. If you accidentally touch it, flush your eyes or skin with a large quantity of water for at least **5 minutes** and seek medical attention immediately.

Electric Shock

Unprotected contact with any electrically charged high-voltage component can cause serious injury or death. Receiving an electric shock from an Acura NSX, however, is highly unlikely because of the following:

- Contact with the battery module or other high-voltage components can only occur if they are damaged and the contents are exposed, or if they are accessed without following proper precautions.
- Contact with the electric motor can only occur after one or more components are removed.
- The high-voltage cables can be easily identified by their distinctive orange color, and contact with them can be avoided.

If severe damage causes high-voltage components to become exposed, responders should take appropriate precautions and wear appropriate insulated personal protective equipment.



Disposal

The lithium-ion battery, the high-voltage battery fluid, and the water used to discharge the battery must be properly disposed of as industrial waste according to local regulations.

Seat Belts and Airbags

The Acura NSX is equipped with lap/shoulder belts in both seating positions. The seat belts are equipped with pyrotechnically activated tensioners that help tighten the seat belt in a sufficient crash.

In addition, the Acura NSX is equipped with the following airbags:

- **Front Airbags** – Driver and Passenger
- **Side Airbags** – Driver and Passenger
- **Side Curtain Airbags** – Driver's Side/Passenger's Side

It takes up to **3 minutes** for the airbags and tensioners to power off after the 12-volt system has been turned off by following the emergency shutdown procedures described in this guide.

In a collision severe enough to deploy one or more of the airbags, the Acura NSX electrical system is designed to automatically open the high-voltage electrical contactors. This disconnects the high-voltage battery from the other high-voltage components and stops the flow of electricity in the high-voltage cables.

However, responders should always assume that the high-voltage system is powered on, and take the appropriate action described in this guide to power off the system.



Vehicle Collision

In the event of a crash, the supplemental restraint system (SRS) unit makes a judgment based on input from the impact sensors. If the input values meet various threshold requirements, the SRS unit sends a signal to the high-voltage battery electronic control unit (ECU). The high-voltage battery ECU then turns off the high-voltage battery contactors, stopping the flow of electrical current from the high-voltage battery.

When responding to an incident involving an Acura NSX, we recommend that emergency personnel follow their organization's standard operating procedures for assessing and dealing with vehicle emergencies.

Acura recommends that responders follow the procedures in this guide to avoid potentially lethal shock from high voltage.



Dealer Inspection and Repair

A damaged Acura NSX should be taken to an authorized Acura dealer for a thorough inspection and repairs. For questions or to locate an authorized Acura dealer, please contact the following:

USA: Your local Acura dealer or Acura Automobile Customer Service at **(800) 382-2238**.

Central America: Your local Acura dealer or distributor.



High-Voltage Battery Recycling

The high-voltage lithium-ion battery requires special handling and disposal. If disposal is necessary, please contact your local Acura dealer or American Honda's Hybrid Battery Consolidation Center at **(800) 555-3497**.



BLUE SKIES FOR
OUR CHILDREN

This guide has been prepared to assist emergency response professionals in identifying a 2017–22 Acura NSX and safely respond to incidents involving this vehicle.

Copies of this guide and other emergency response guides are available for reference or downloading at <https://techinfo.honda.com>.

For questions, please contact the following:

USA: Your local Acura dealer or Acura Automobile Customer Service at **(800) 382-2238**.

Central America: Your local Acura dealer or distributor.

Acura wishes to thank emergency response professionals for their concern and efforts in protecting Acura clients and the general public.



Components

High-Voltage Components



12-Volt Battery



SRS Components

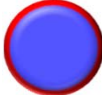

Fuel Tank



Gas Strut



Reinforcement



Seat Belt Pretensioners

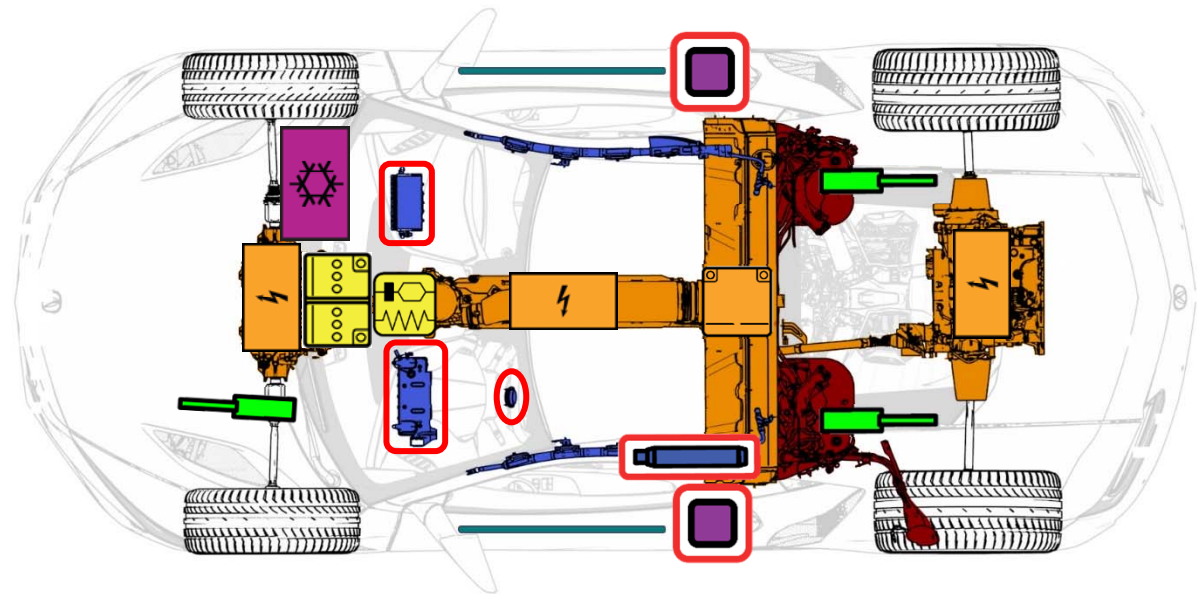
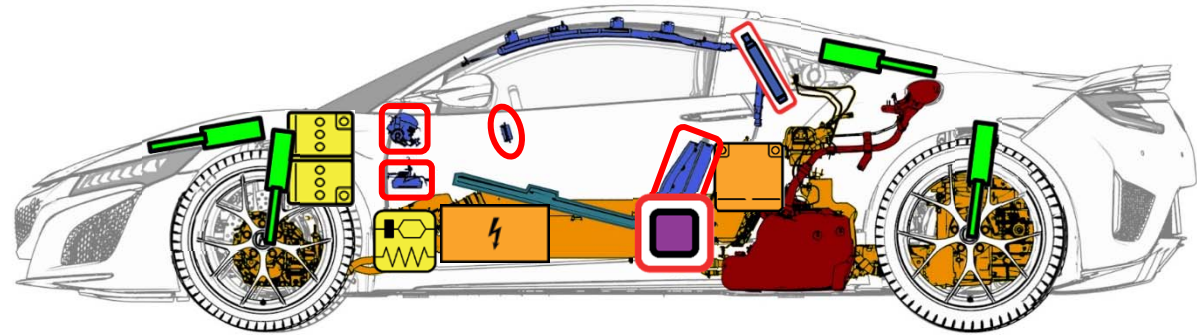

Pictogram	Name	Pictogram	Name
	Hood release/opener control		High-voltage battery pack
	Power switch		High-voltage component
	Keyless operation key distance		High-voltage power cable
	Fuse box disabling high-voltage		Fuel tank (gasoline)
	Cable to cut to disconnect high-voltage		Air-conditioning component
	High-voltage service plug		General warning
	Steering wheel height adjustment control		Electricity or dangerous voltage
	Seat height adjustment control		Use a thermal infrared camera
	Forward or backward seat adjustment control		Use water to extinguish the fire
	Lifting point		Use ABC powder to extinguish the fire
	Airbag		Flammable
	Airbag inflator		Gases under pressure
	Seat belt pretensioner		Corrosive
	12-volt battery		Hazardous to human health
	SRS control unit		Environmental hazard

HONDA